

01

escala 1:40  
Estrutura

SmartLights Project Mestrado em Design Industrial  
Sergey Teplov

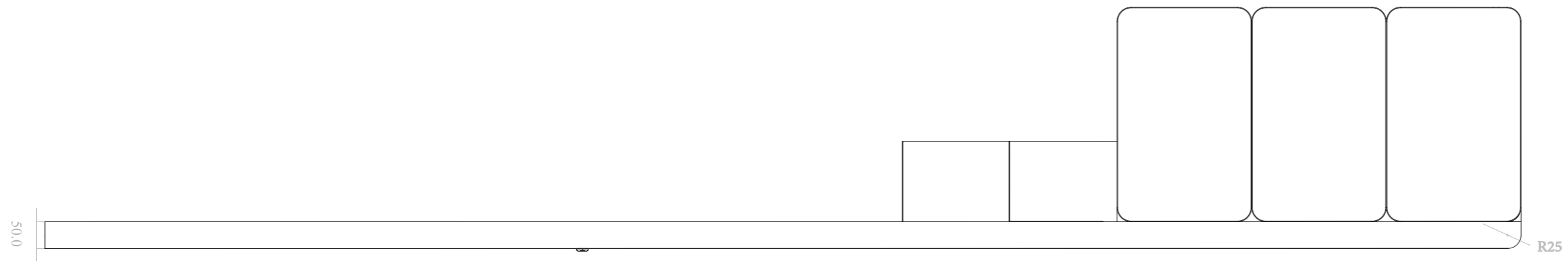
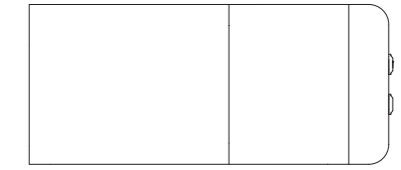
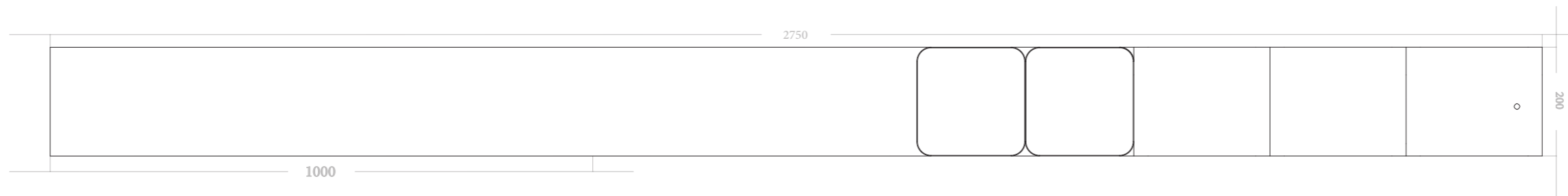

02

escala 1:10  
parafuso de fixação  
do modulo  
SafetyLights

SmartLights Project Mestrado em Design Industrial  
Sergey Teplov

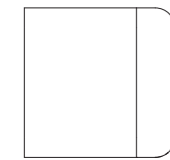
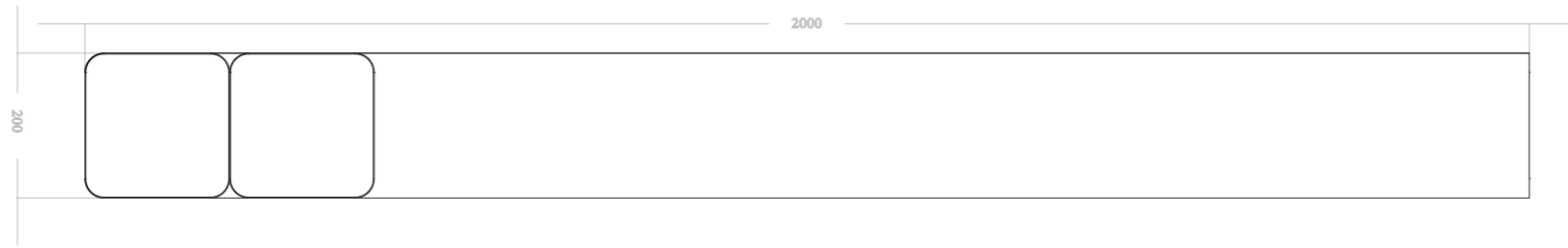

03

escala 1:10  
parafuso de fixação  
do modulo  
SafetyLights

SmartLights Project Mestrado em Design Industrial  
Sergey Teplov

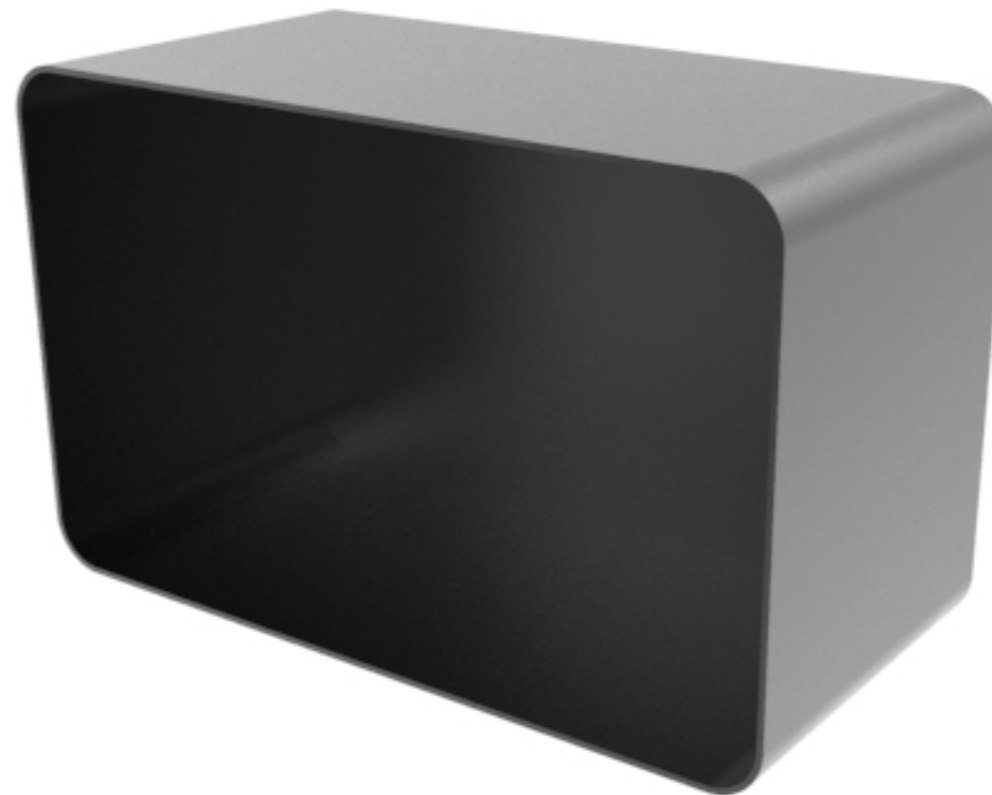
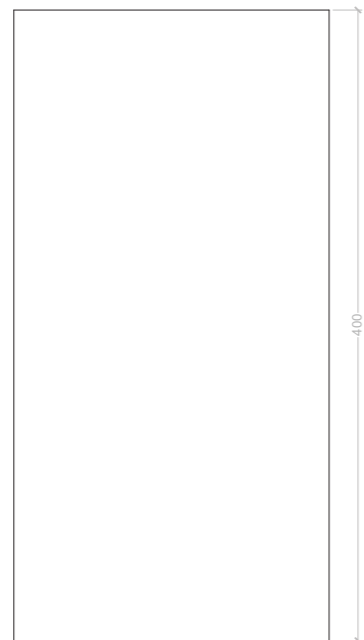
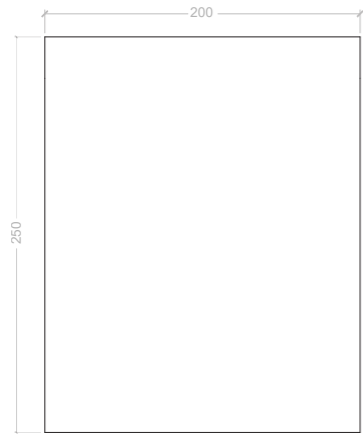

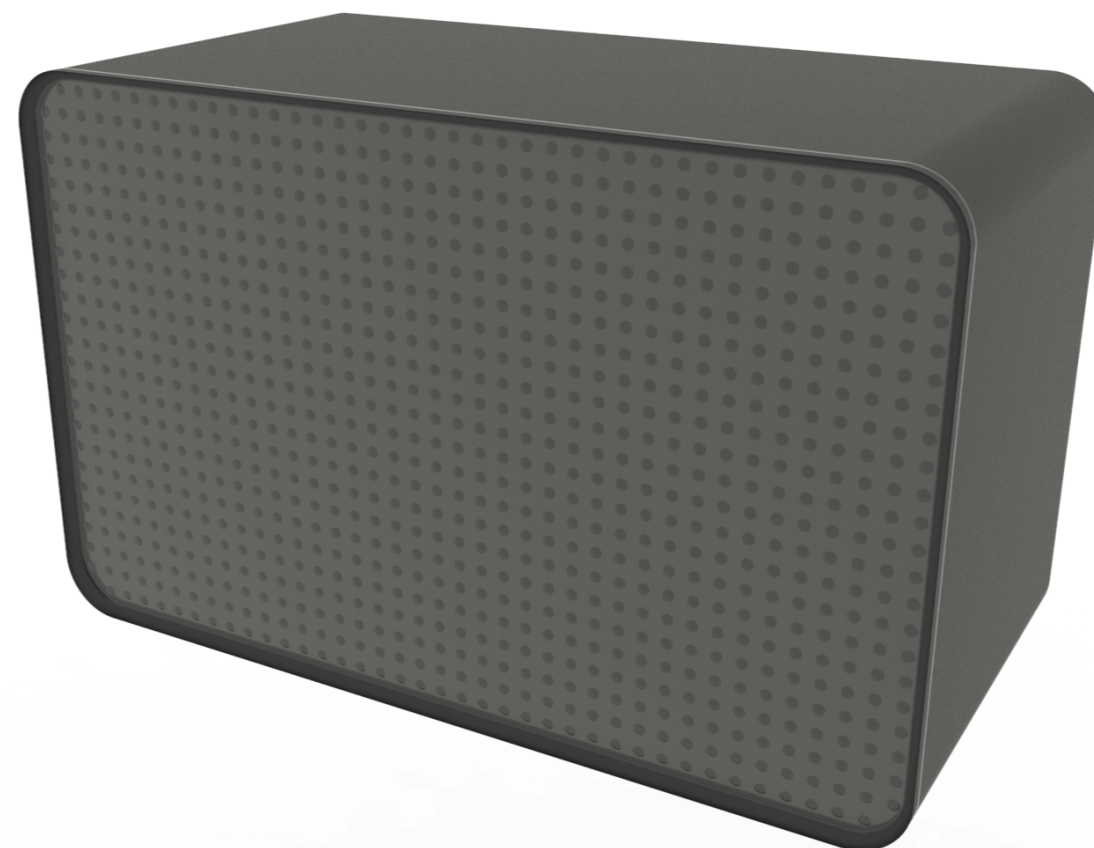
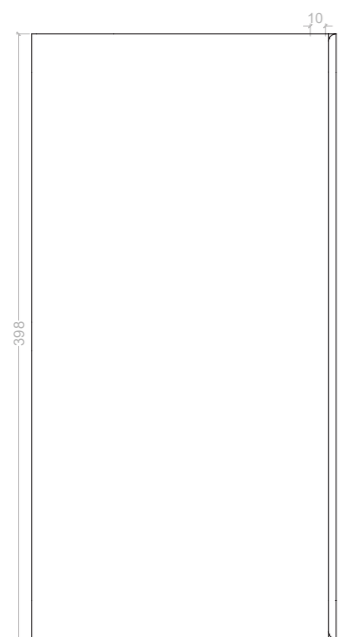
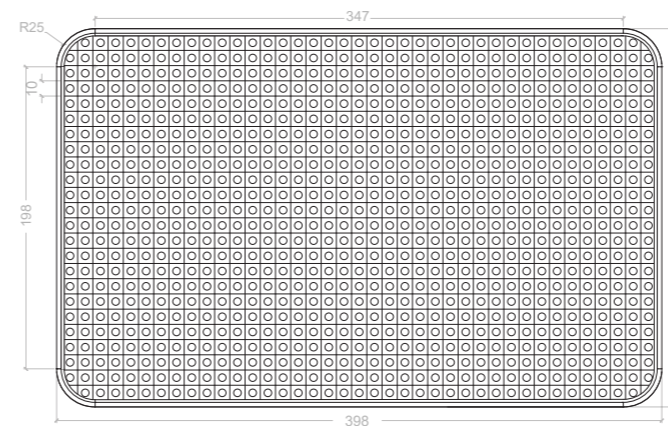
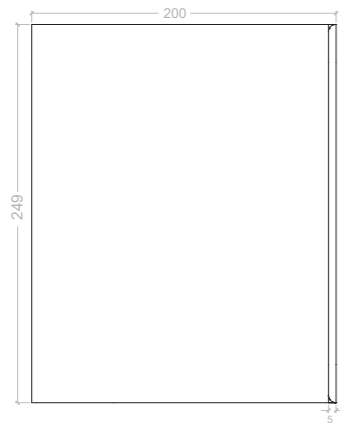

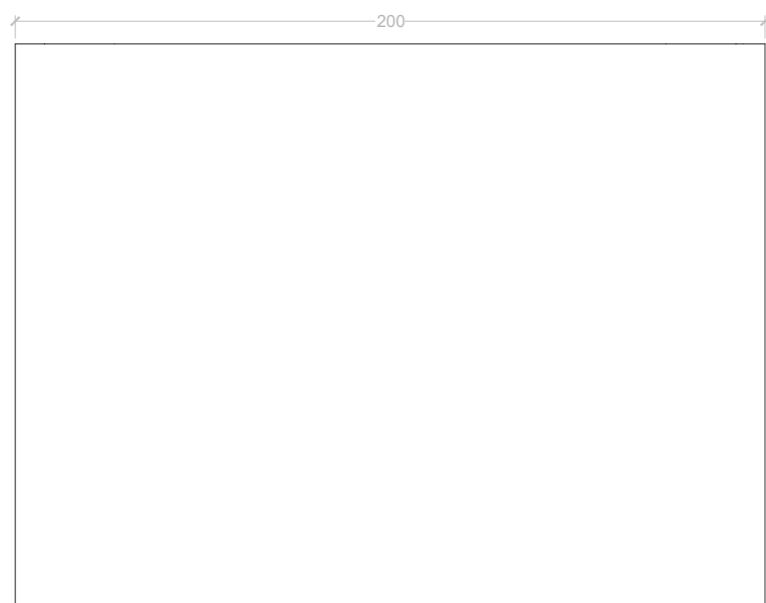
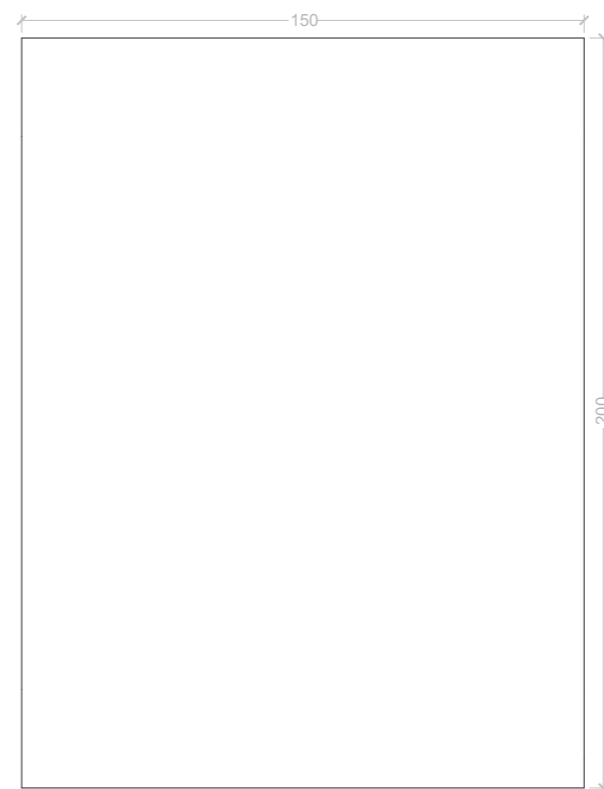
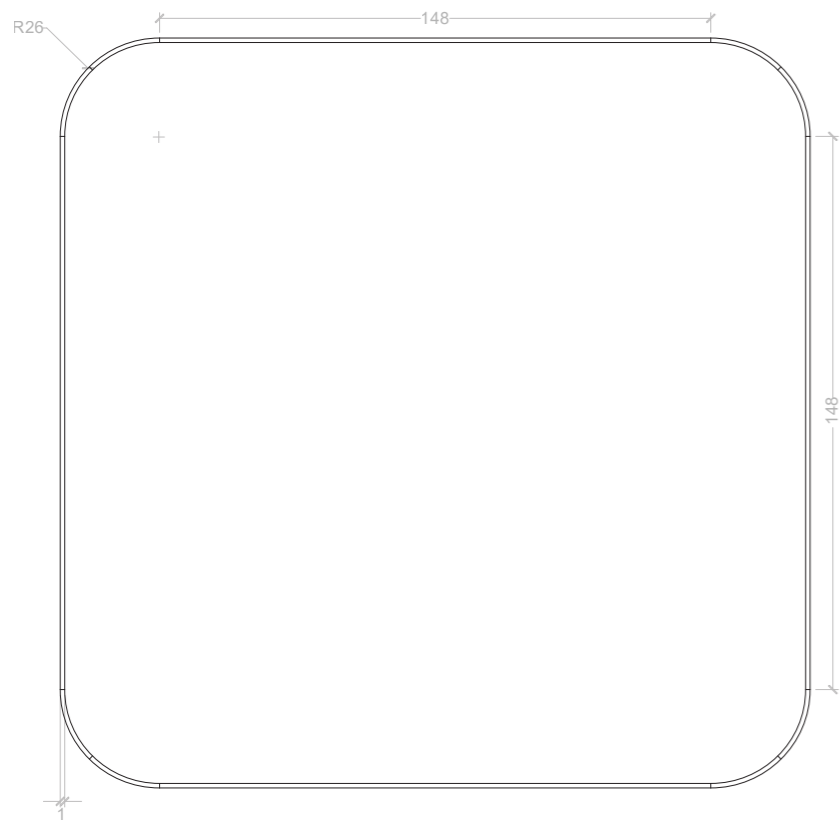

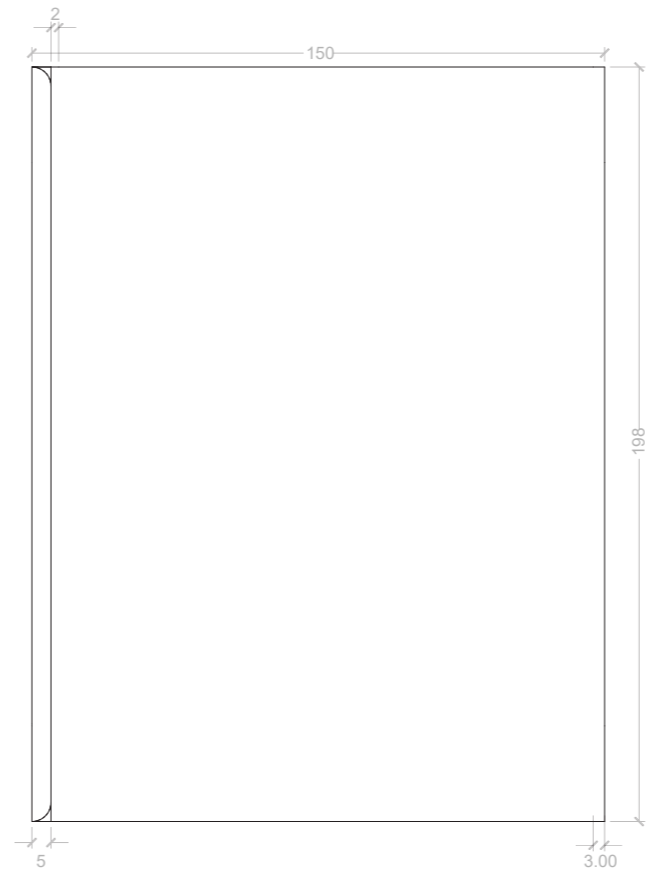
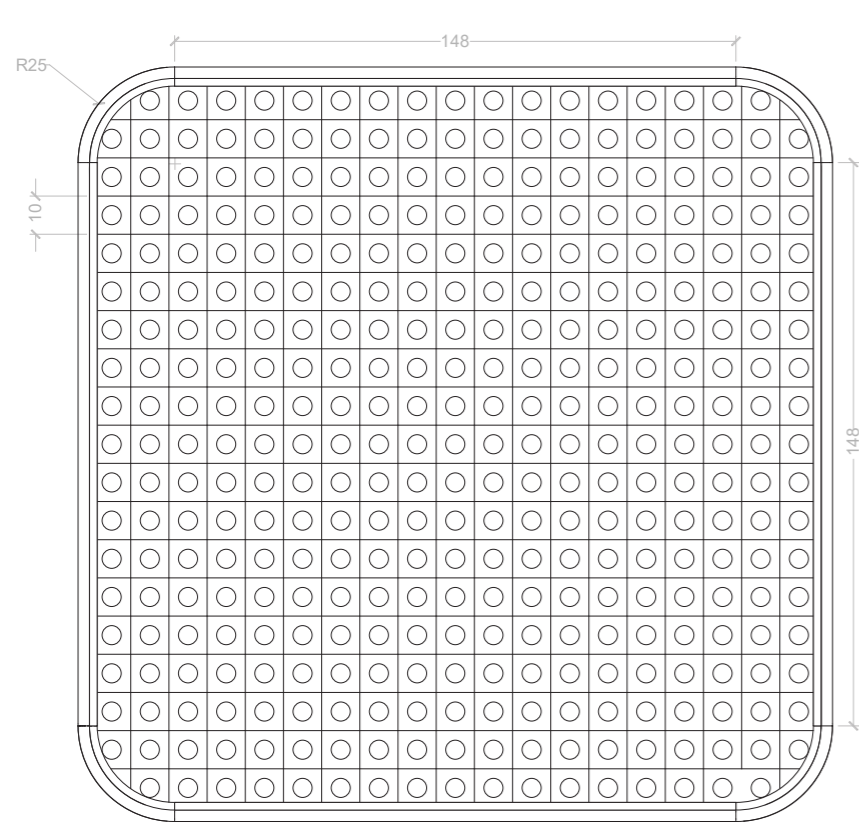

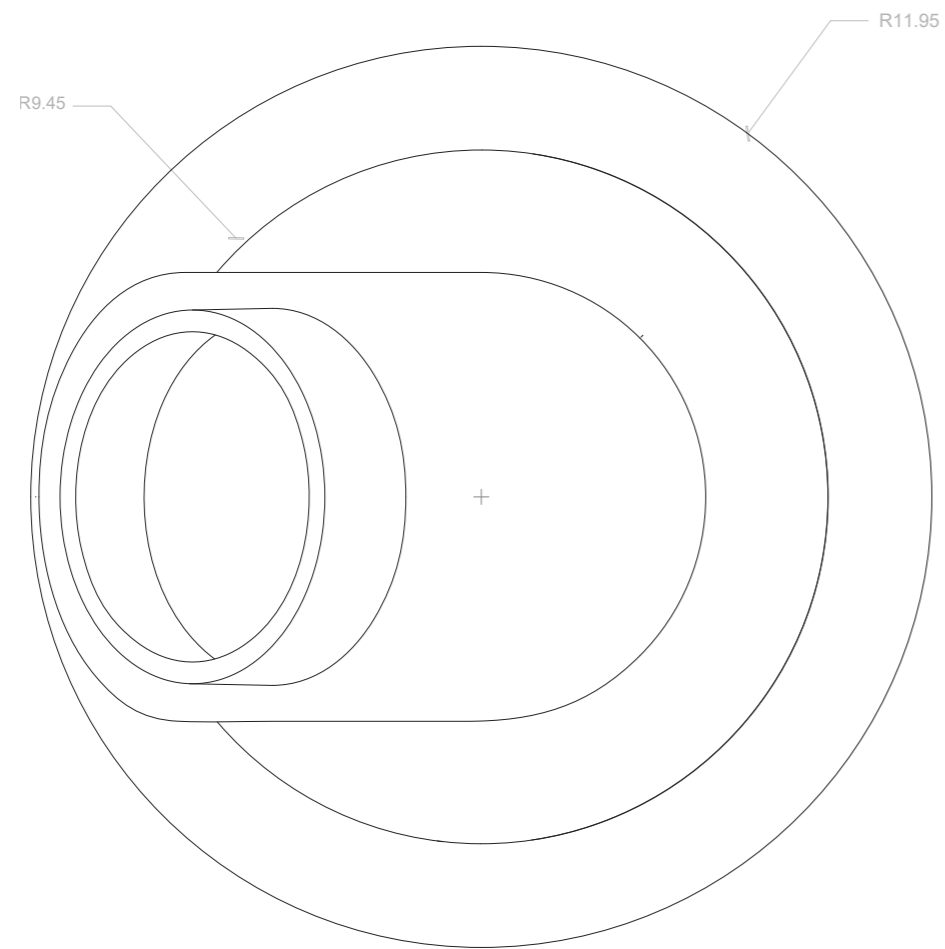
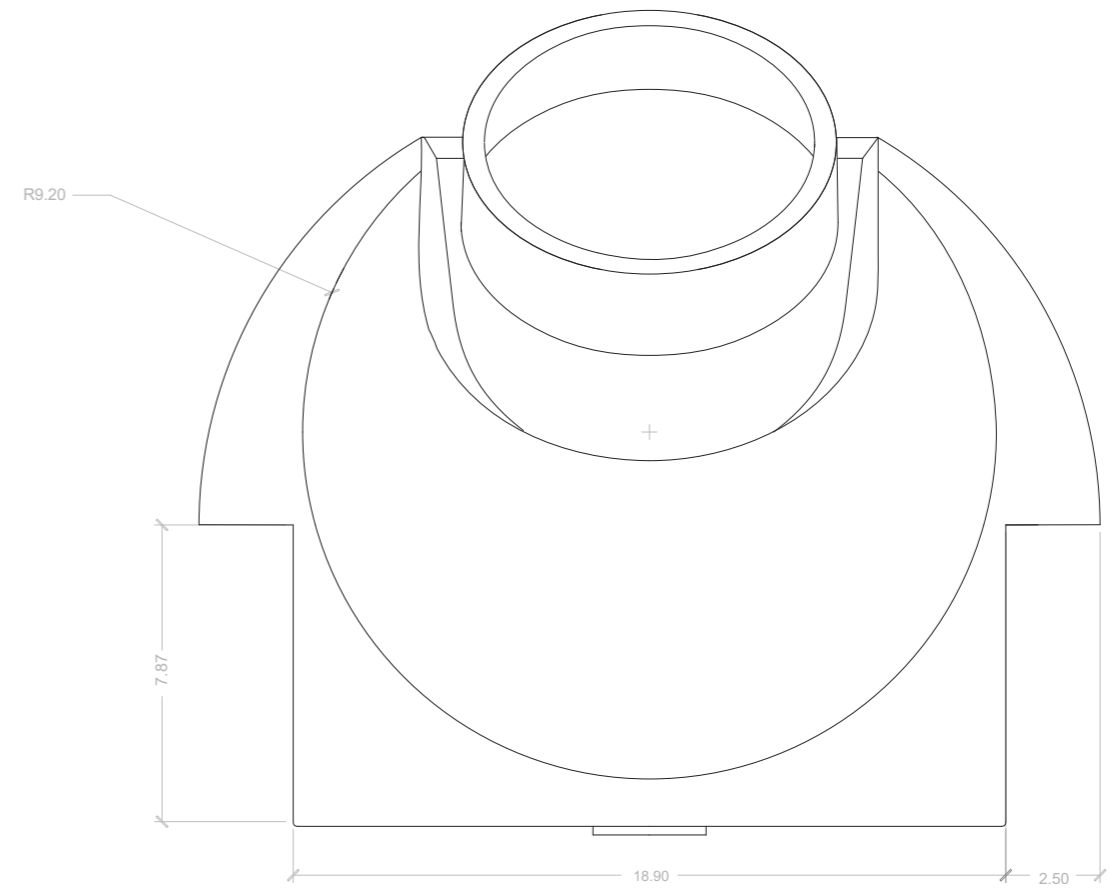
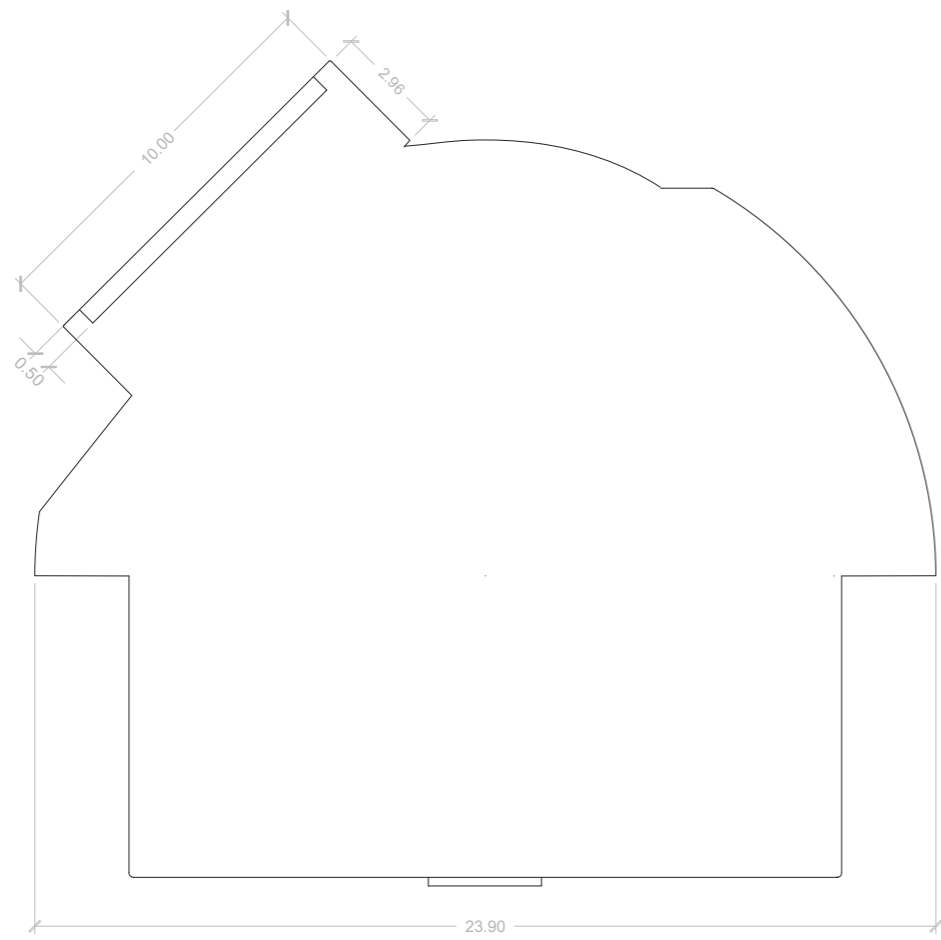



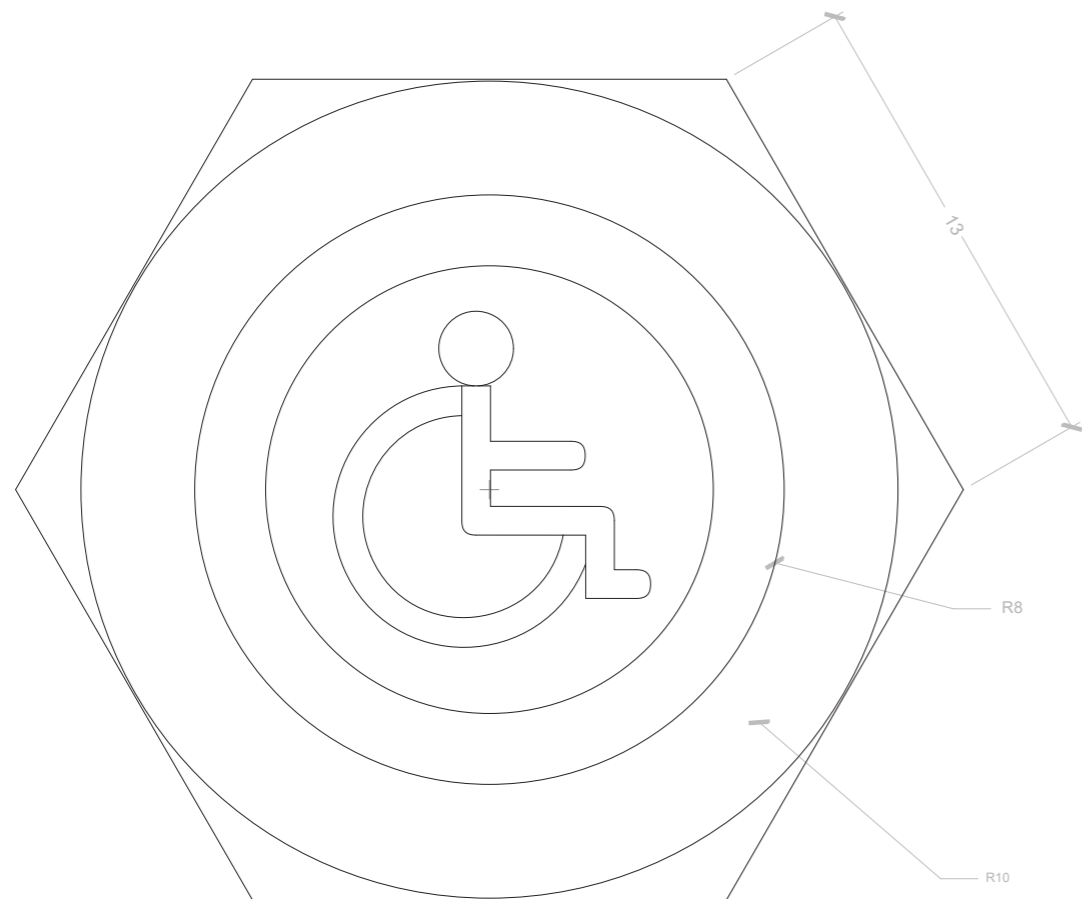
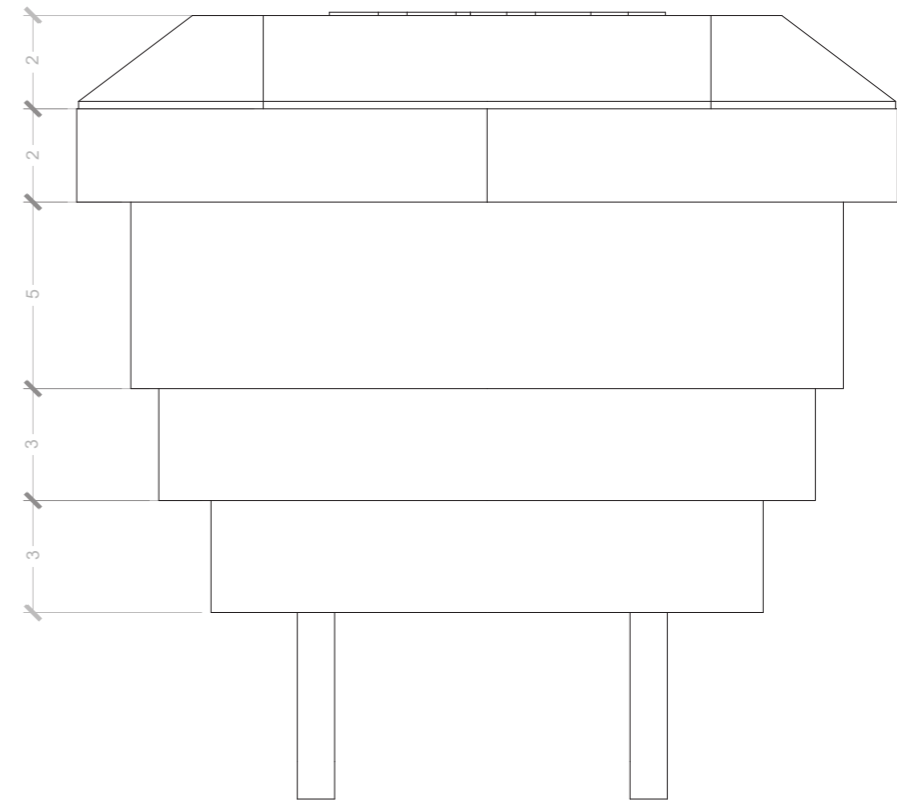
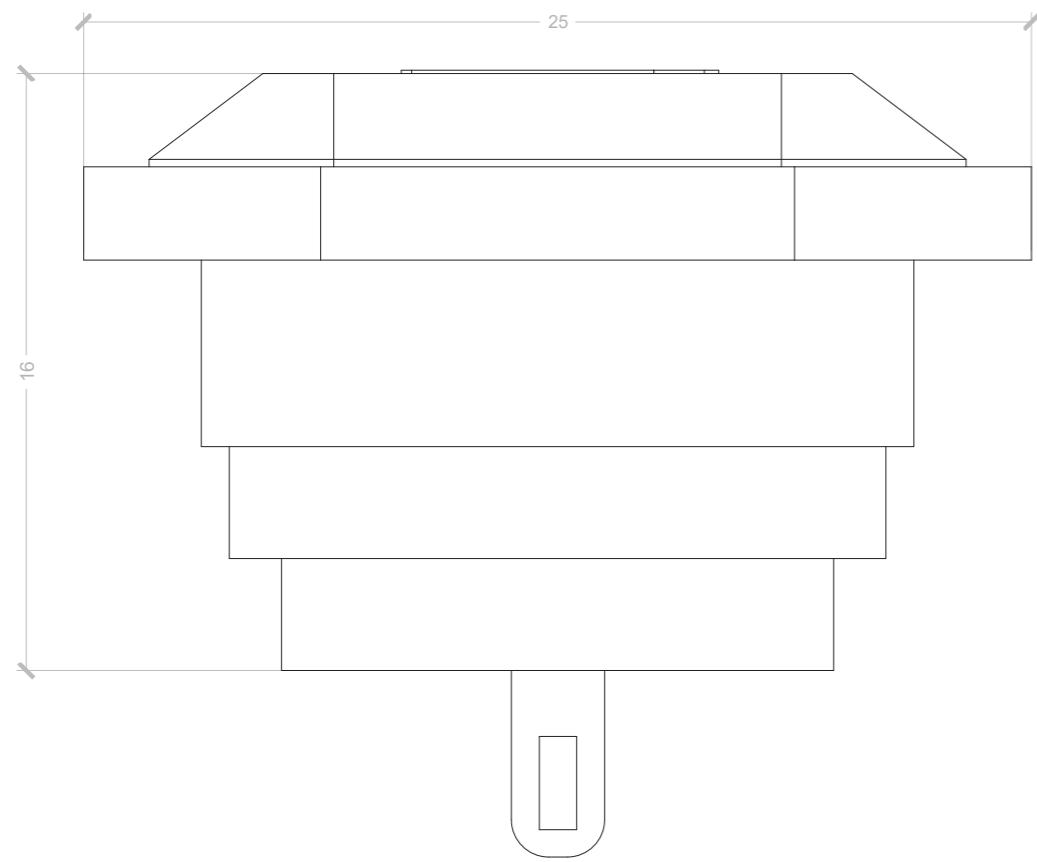

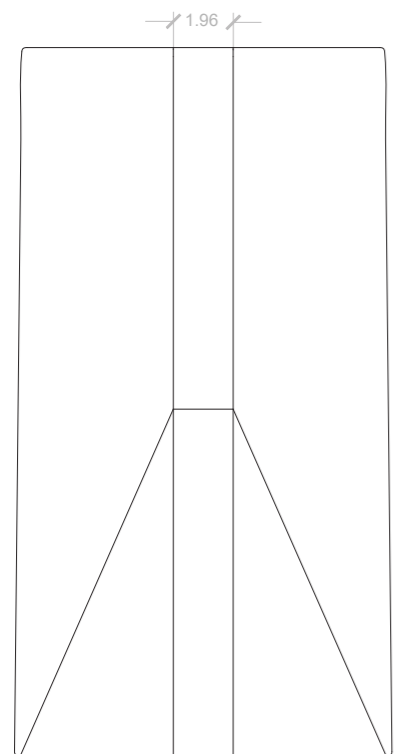
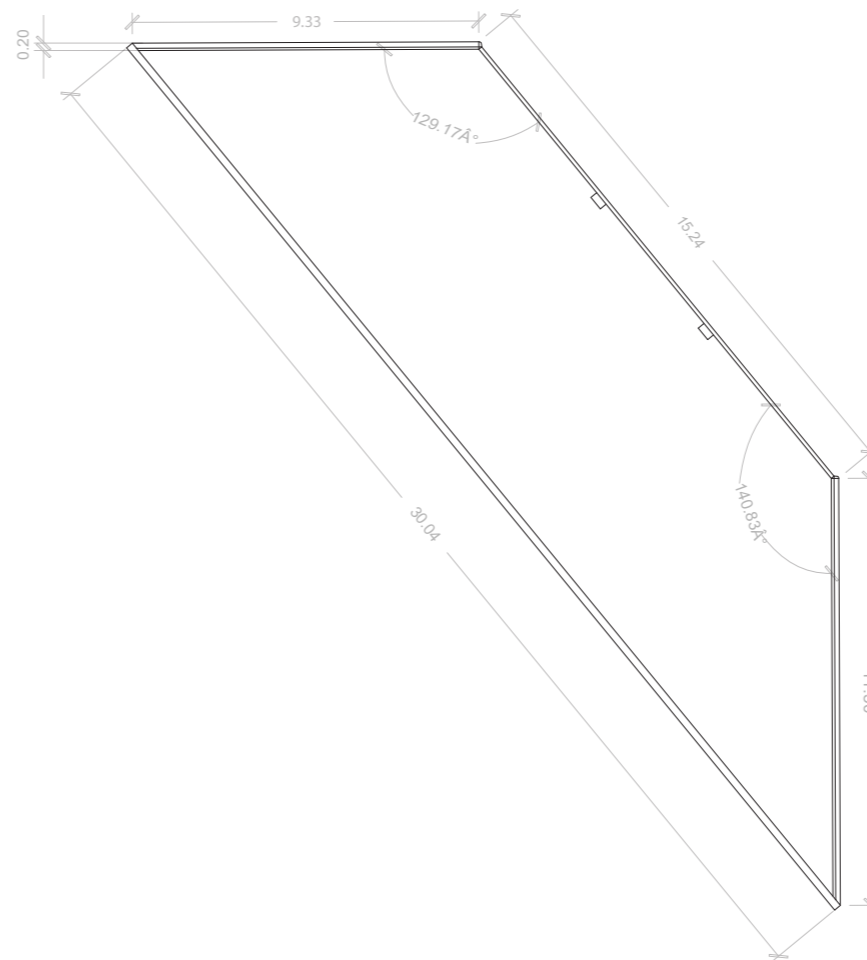
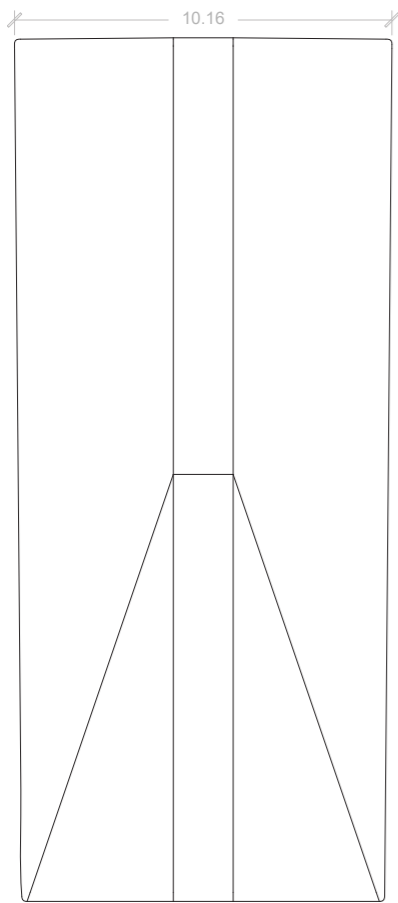

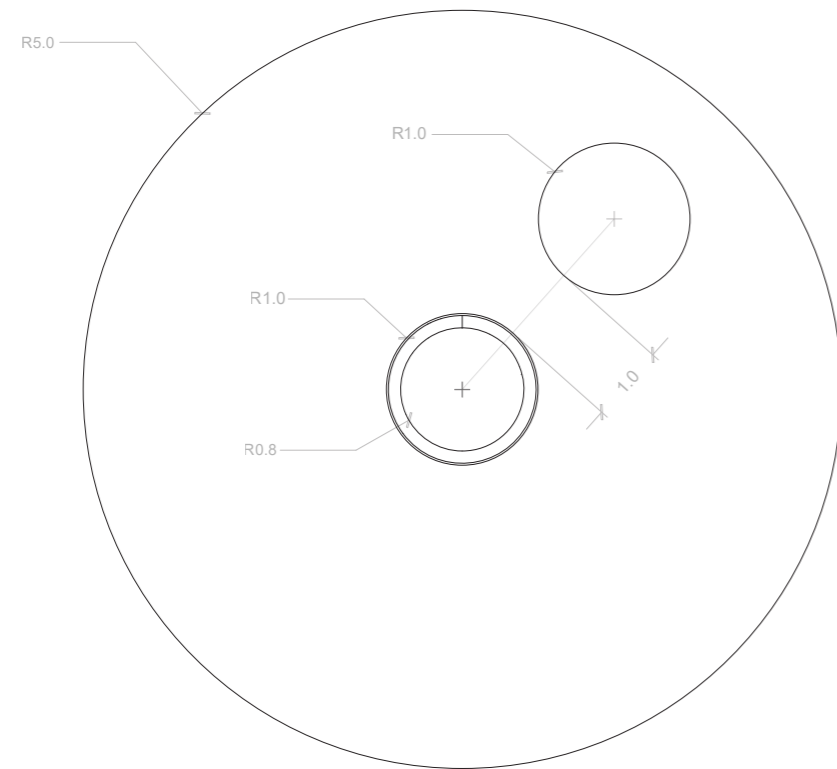
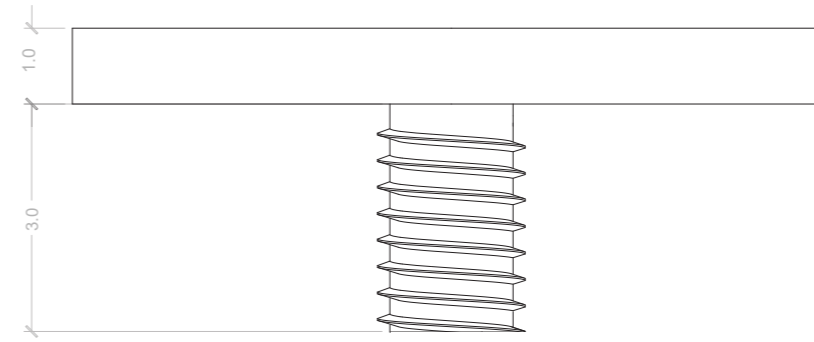
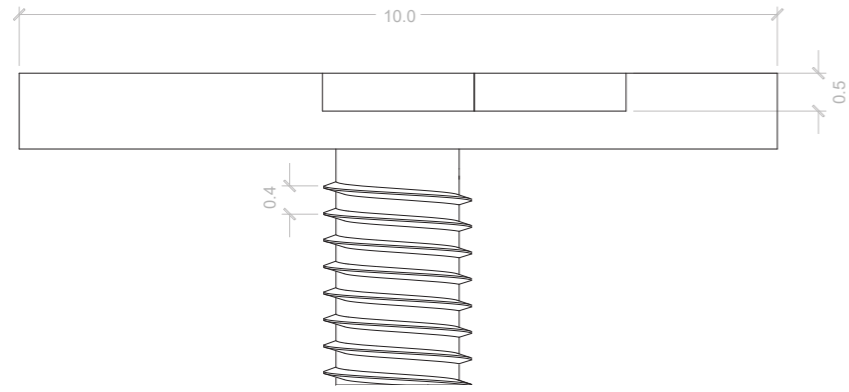

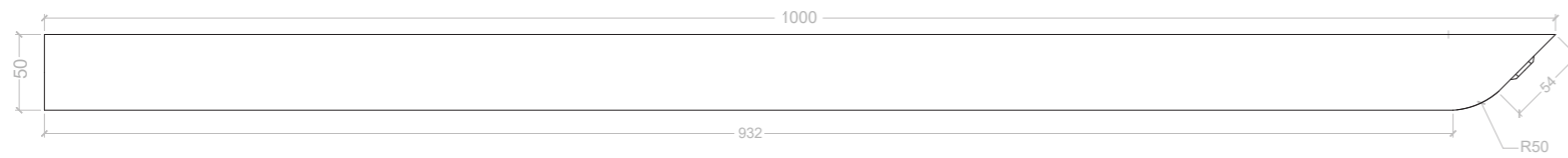
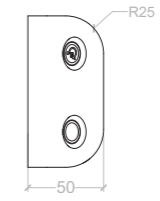

12

escala 1:5  
poste com botões  
SafetyLights

SmartLights Project Mestrado em Design Industrial  
Sergey Teplov

