

ÁLBUM DE DESENHOS ANEXO II

(Este anexo surge como versão reduzida do álbum de desenhos original, em formato A3, disponível na apresentação pública.)

“Fiado do que os olhos julgaram ter visto, o cérebro da cabeça afirma que, segundo a luz e os sonhos, o vento e a calma, a humidade e a secura, a praia é branca, ou amarela, ou dourada, ou cinzenta, ou roxa, ou qualquer coisa entre isto e aquilo, mas depois vêm os dedos e, com o movimento de recolha, como se estivessem a ceifar uma seara, levantam do chão todas as cores que há no mundo. O que parecia único era plural, o que é plural sê-lo-á ainda mais.”

José Saramago¹

¹SARAMAGO, José (2000), *A Caverna*, Lisboa: Edições Caminho, pág.32.



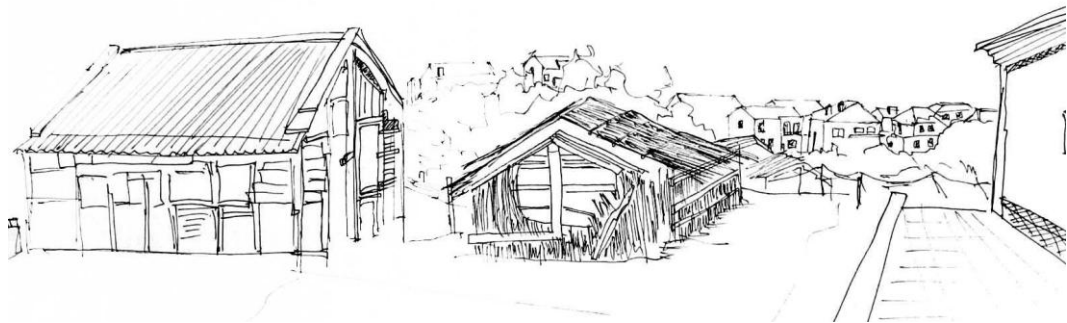

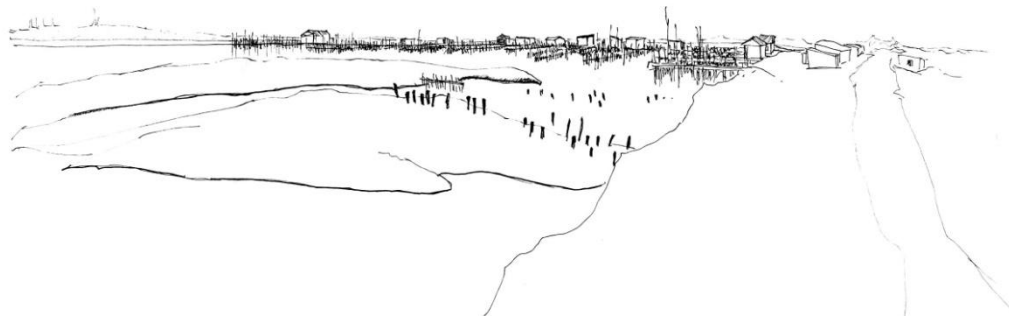



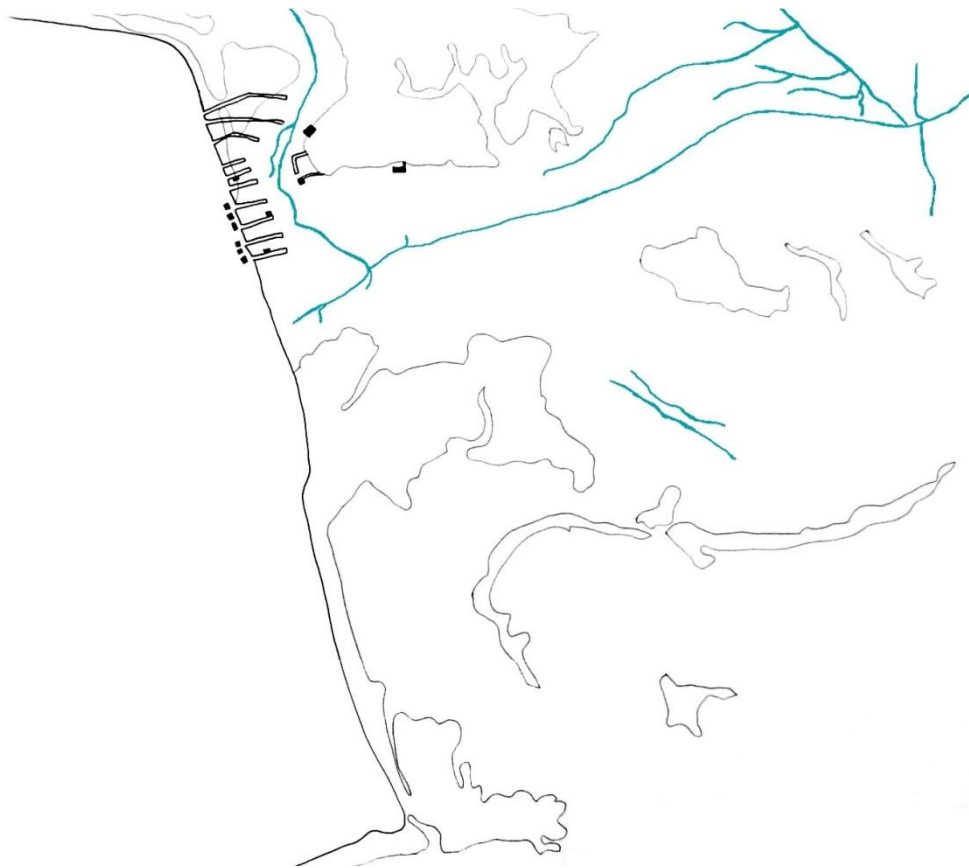









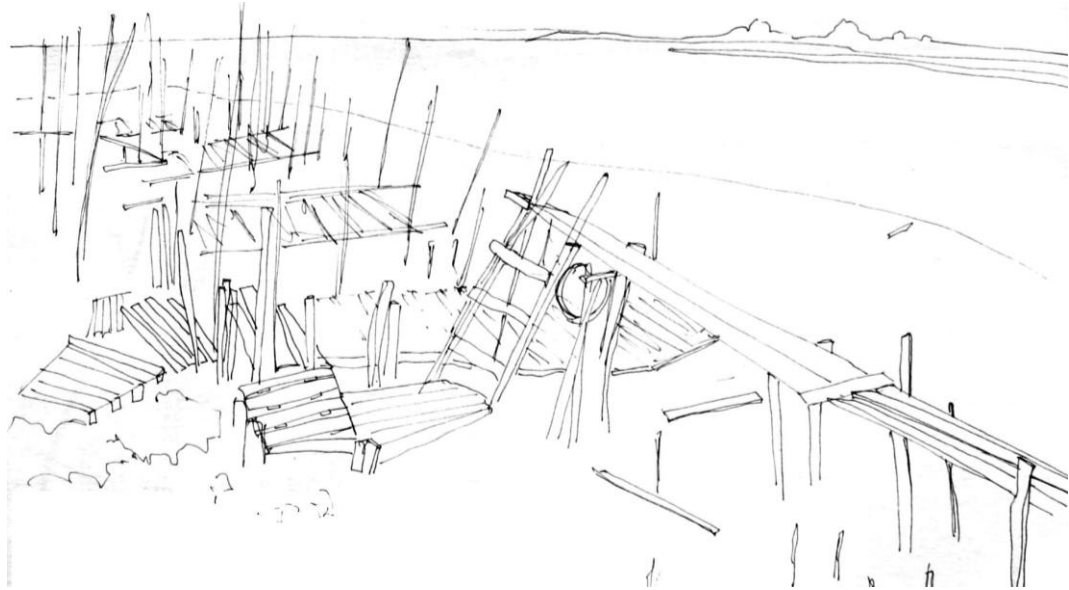

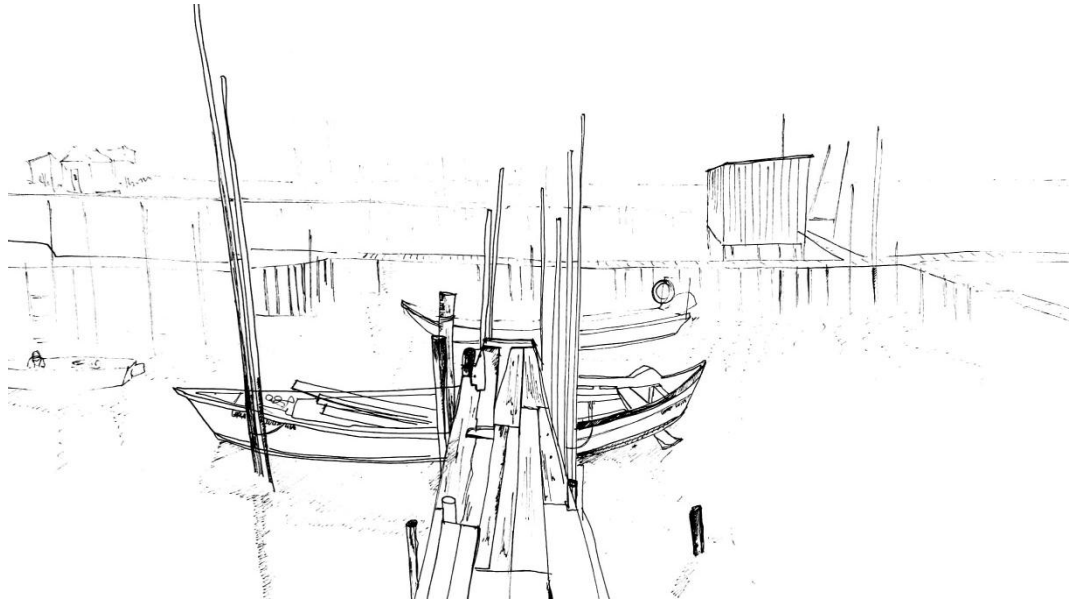

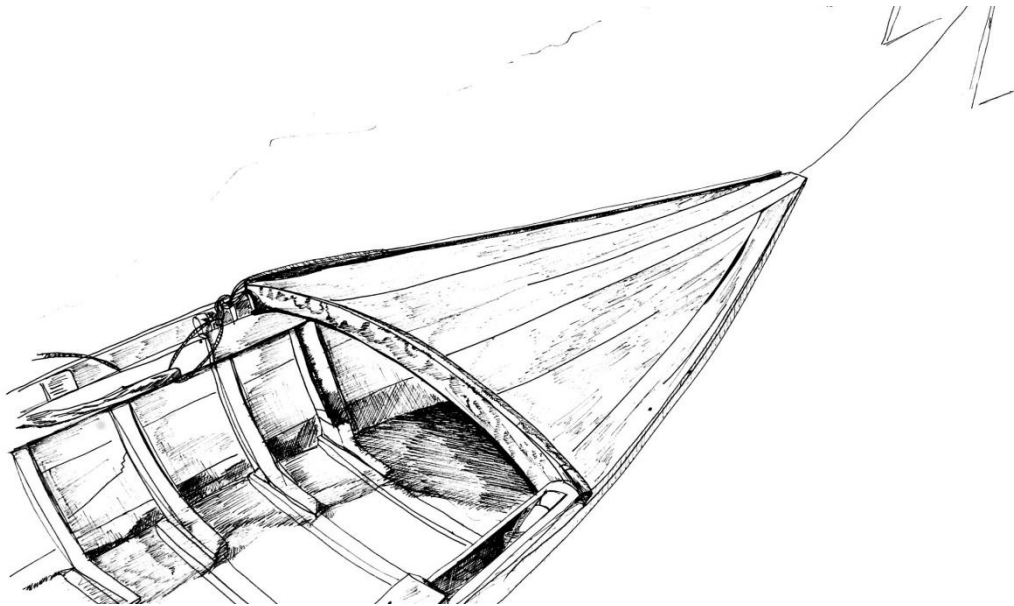

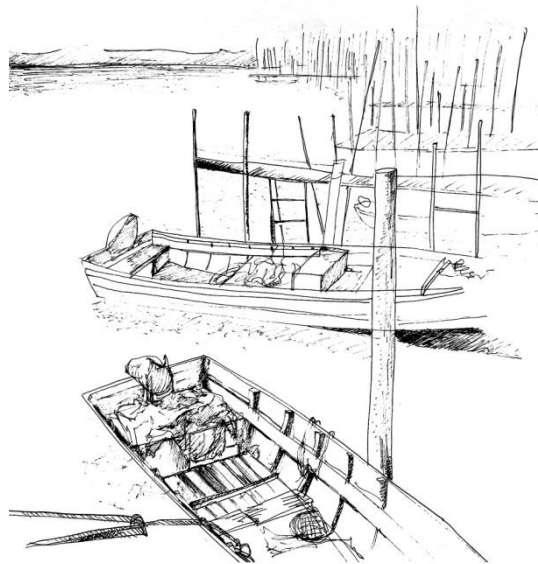

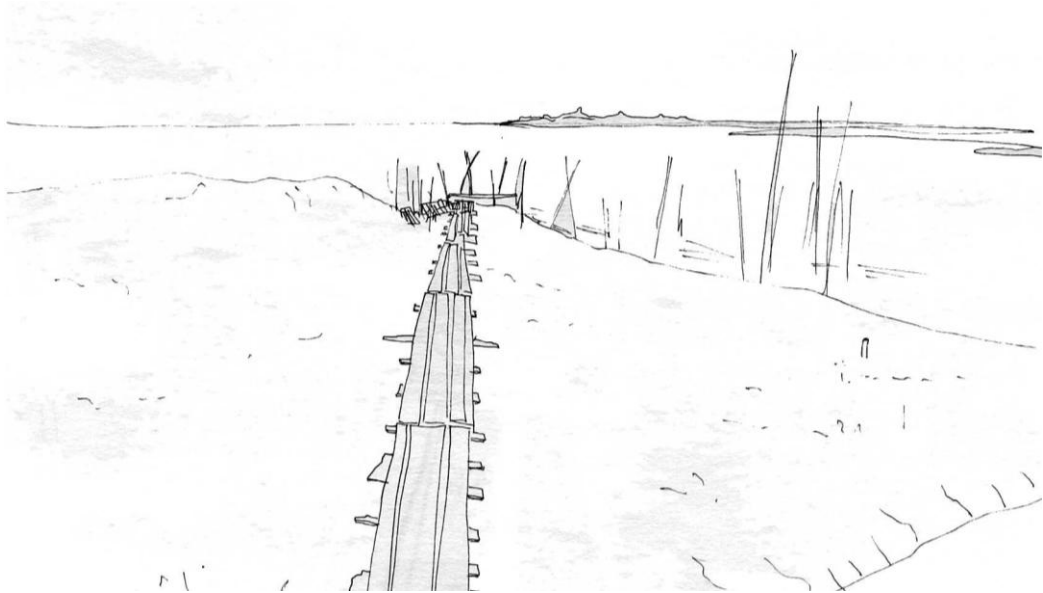

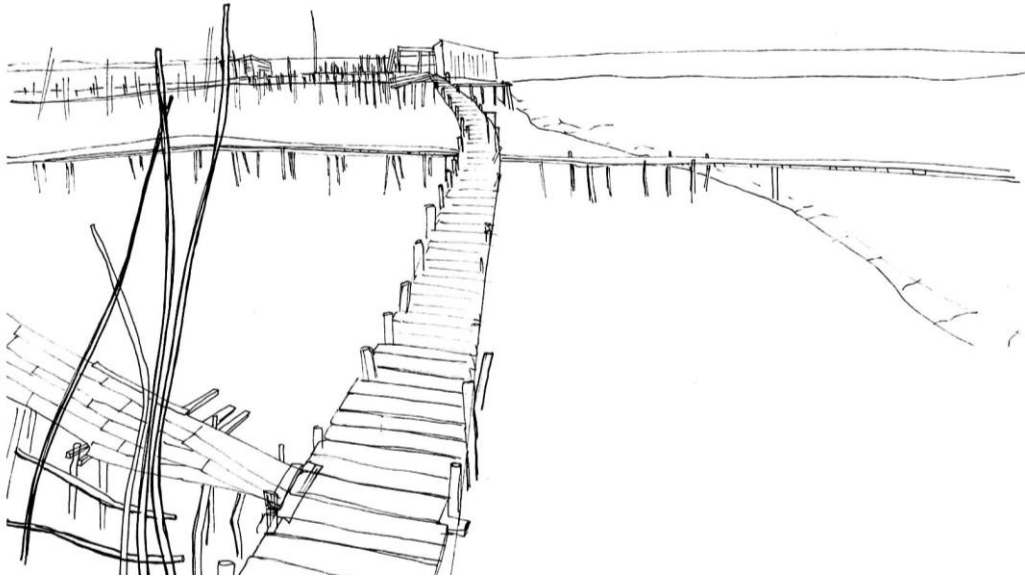

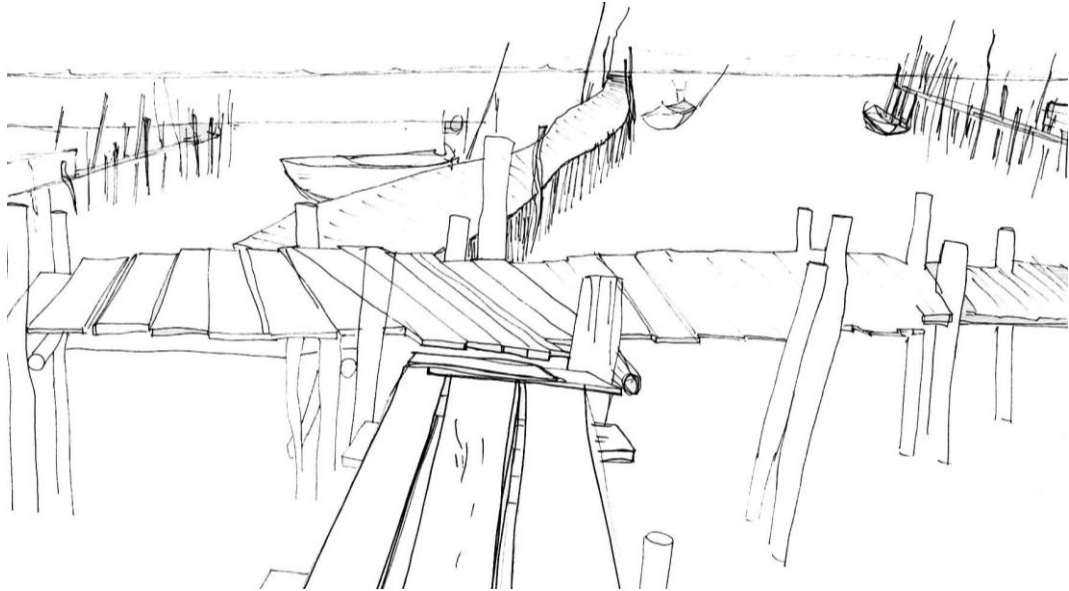

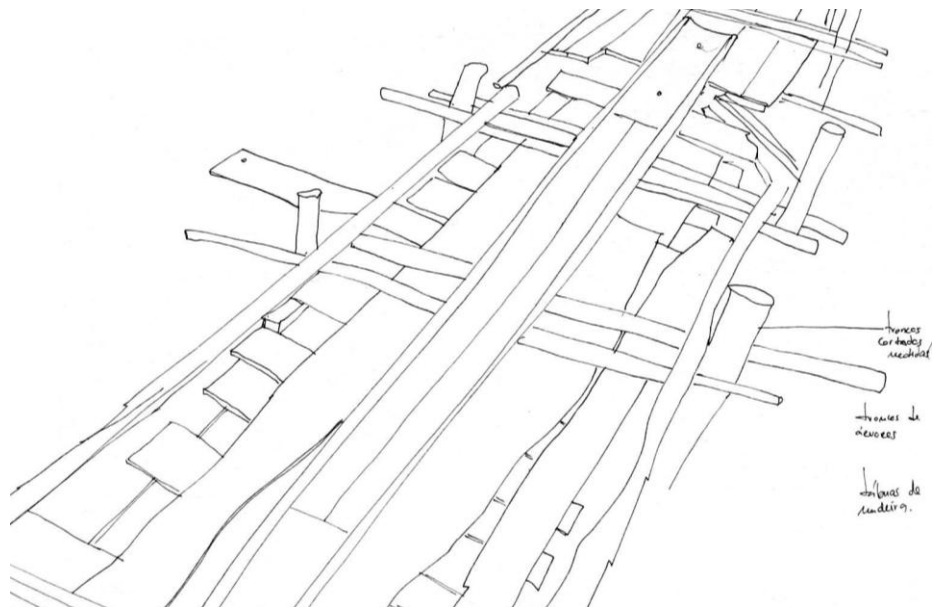

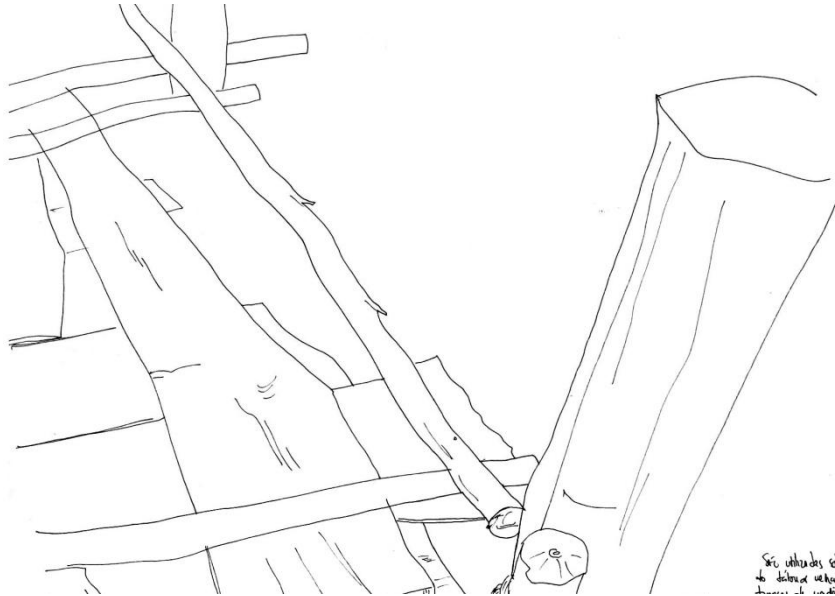

Seu unhas das edo
no debruço velhas
deu-se de modo

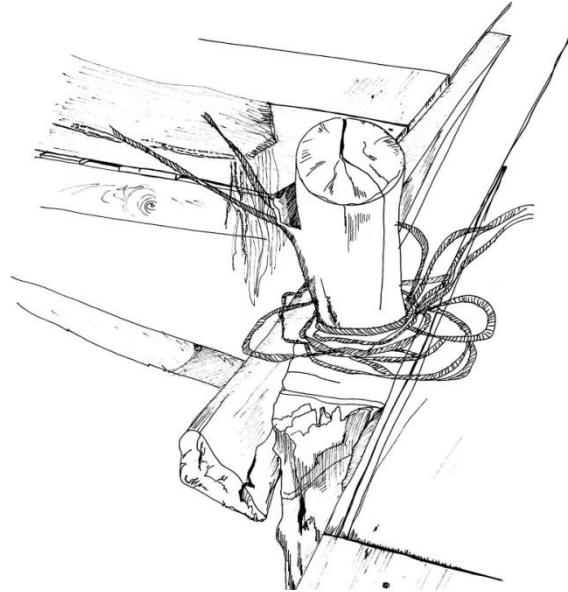

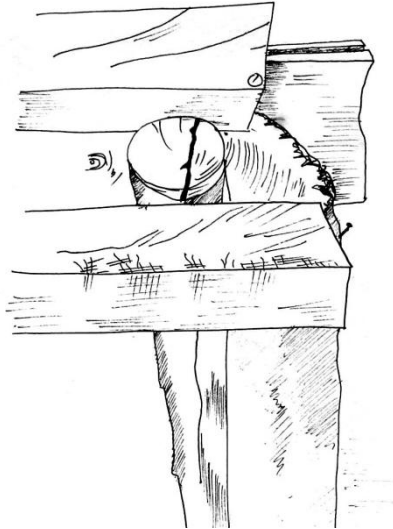





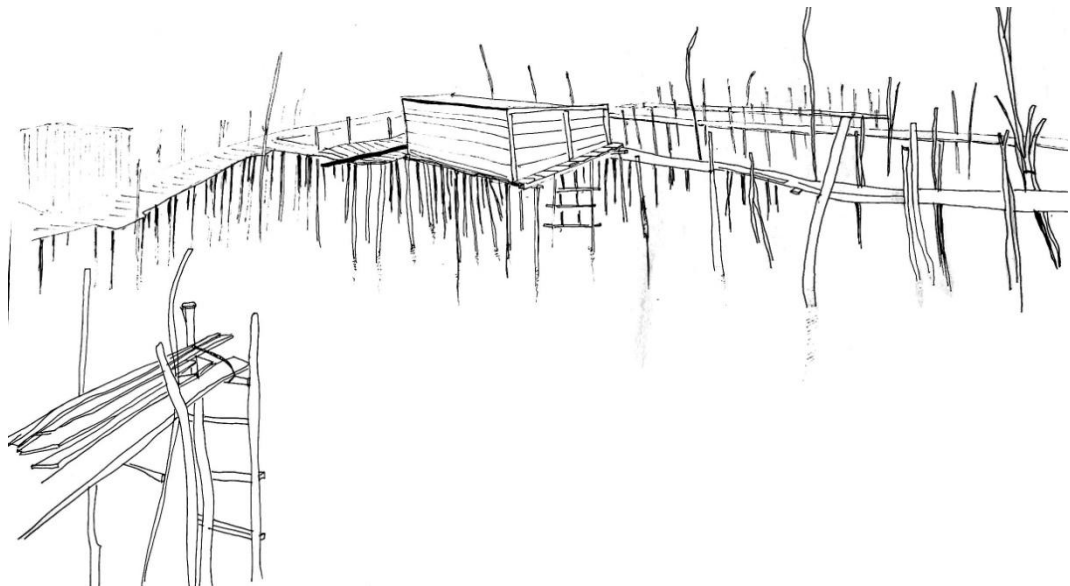

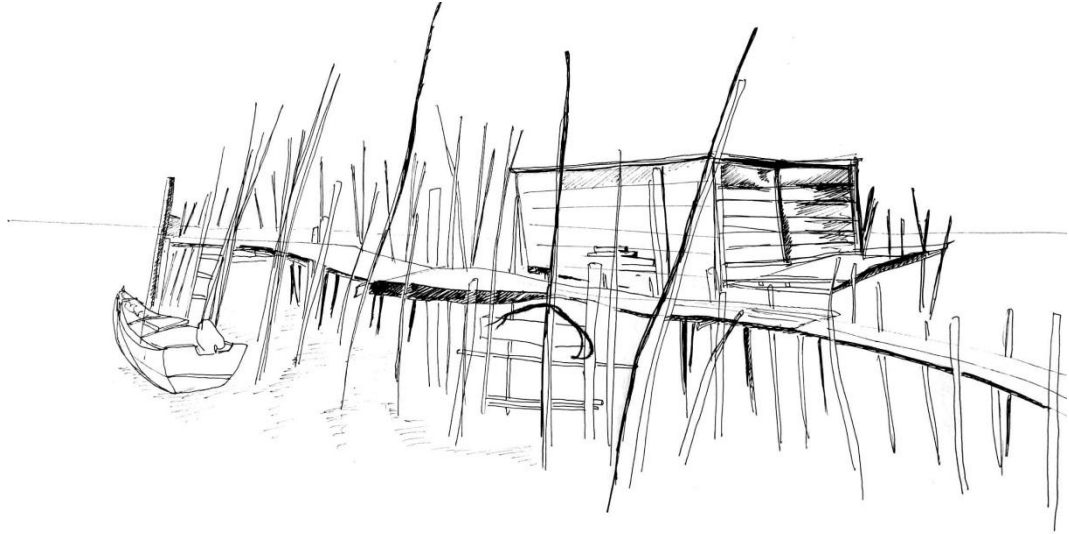

Os veterinários
vêm trabalhar
cabeleiros | feixes de madeira (nessa lagoa em madeira)
de madeira | Puro
de madeira |
particular, mas que sempre da madeira da Colômbia

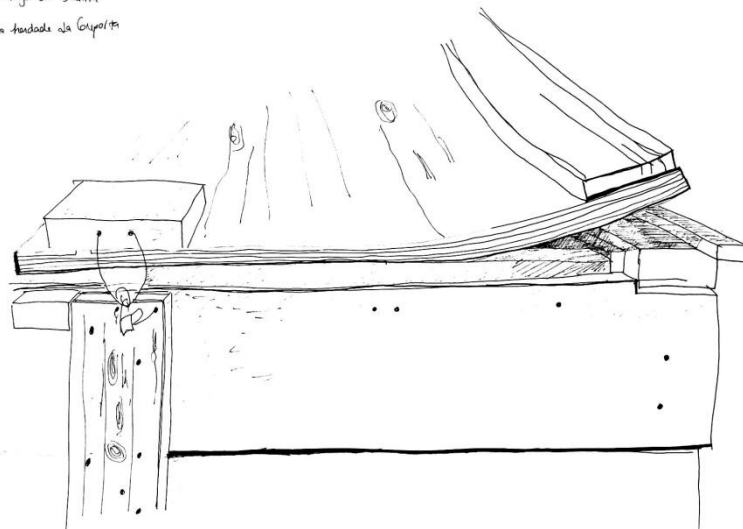

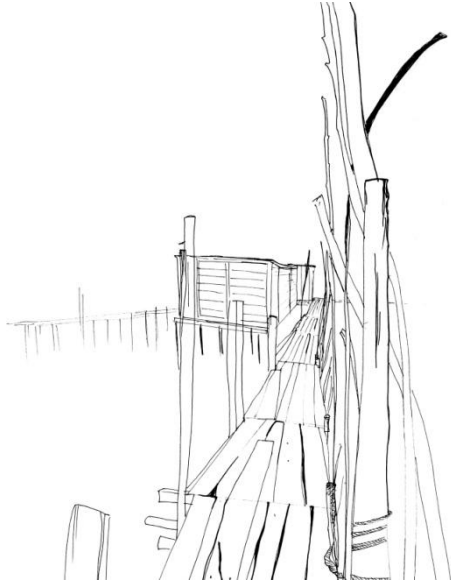



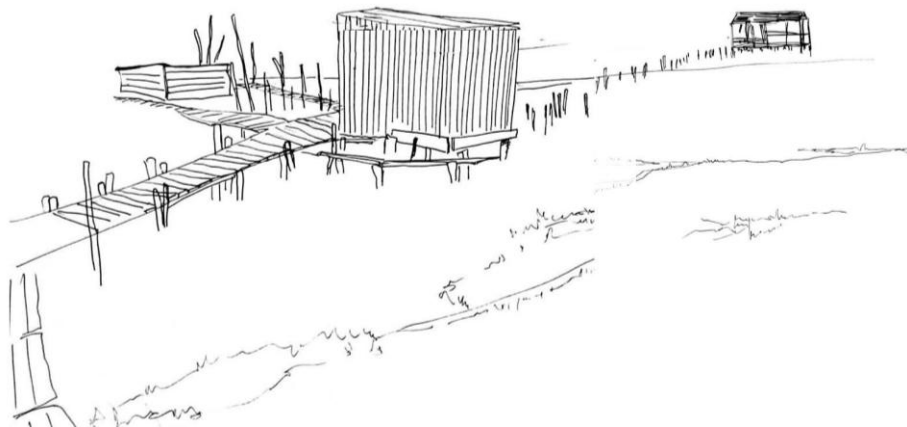

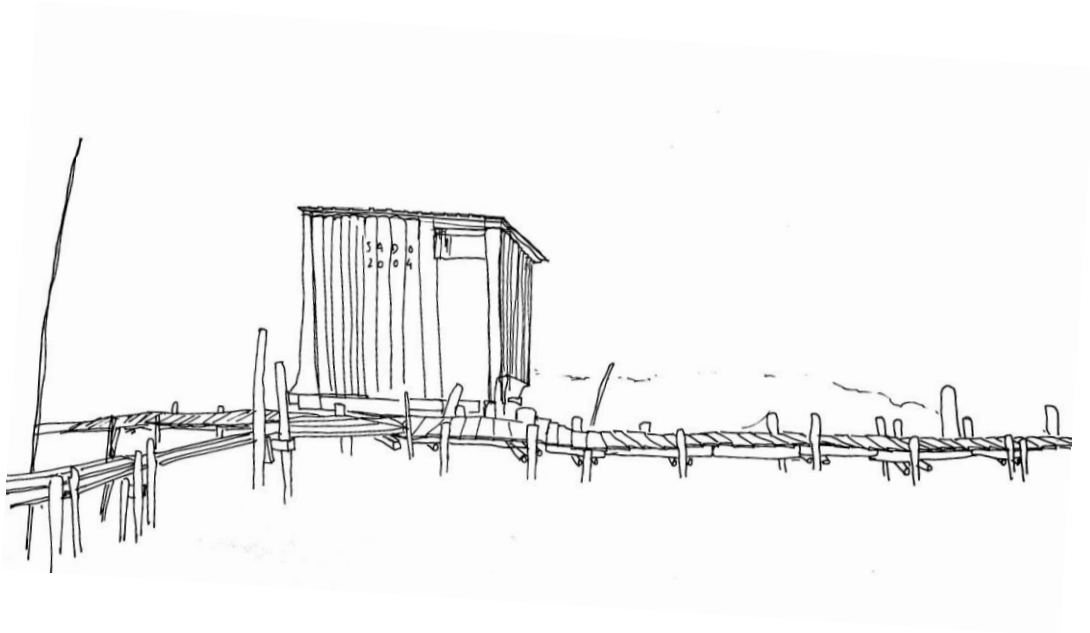



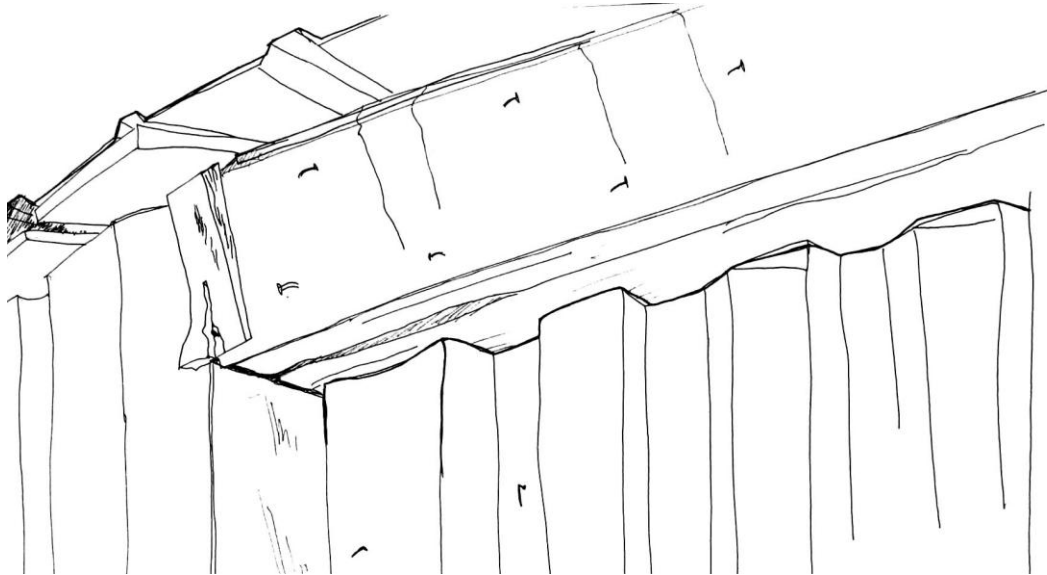

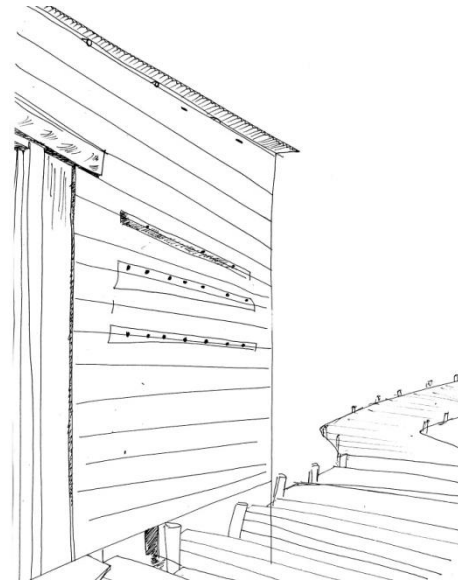

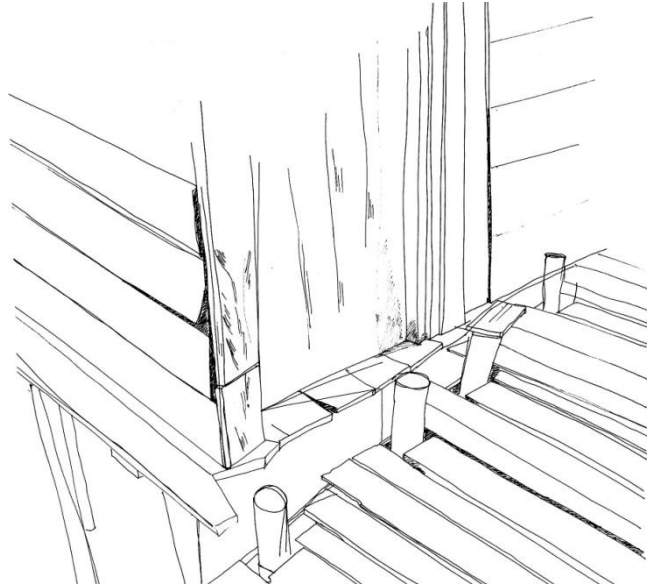

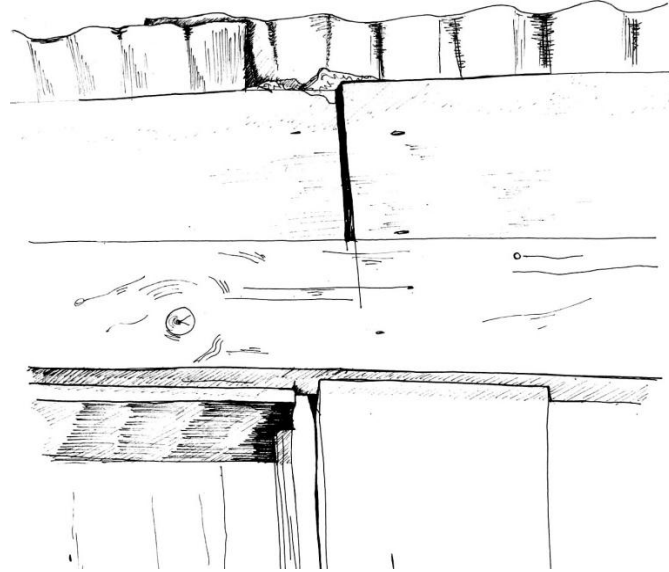



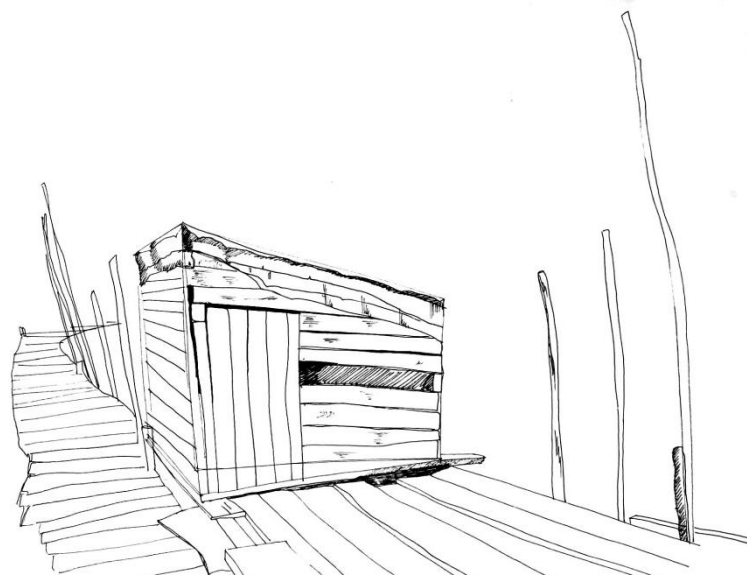

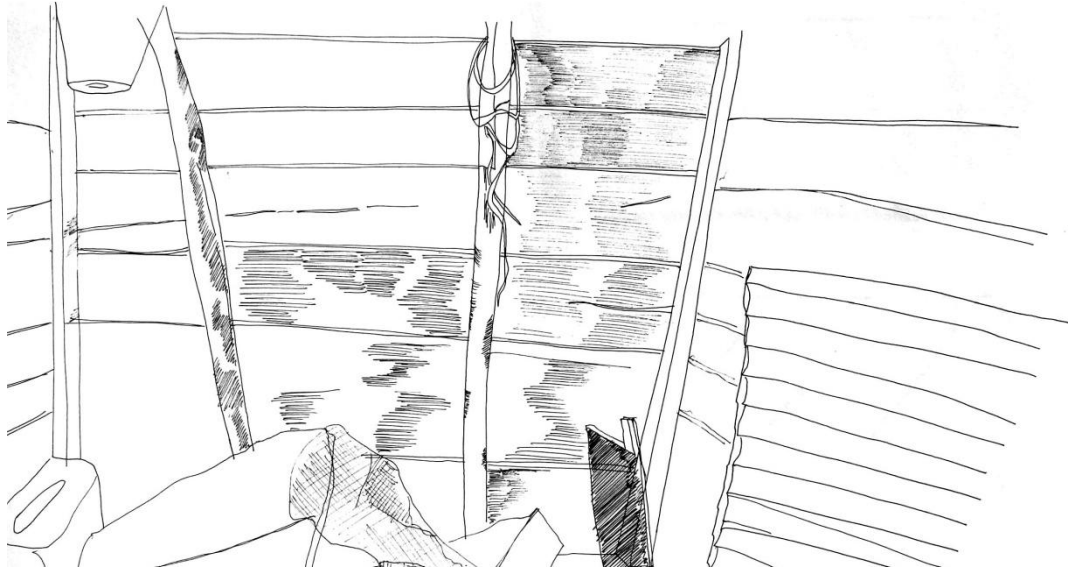

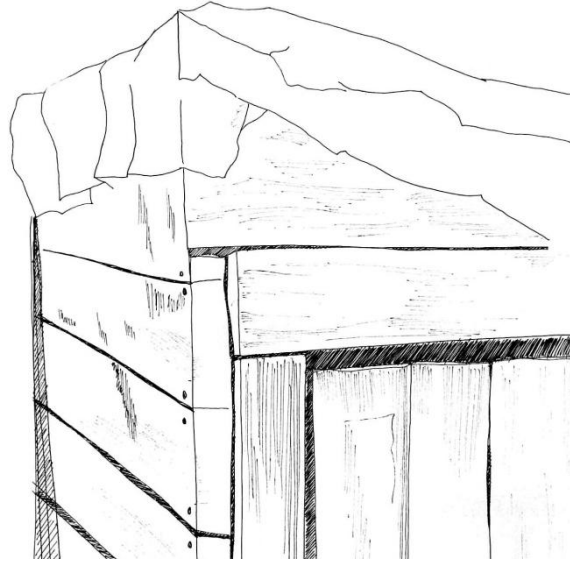

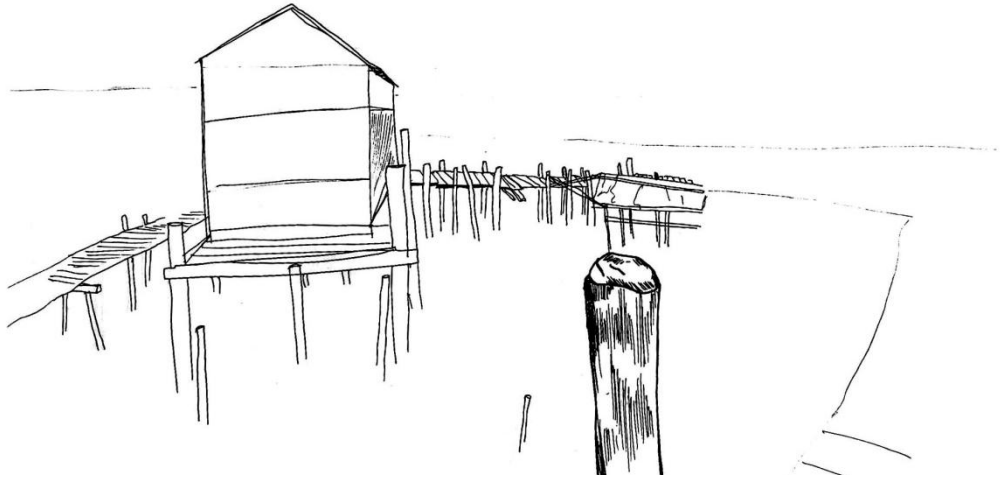

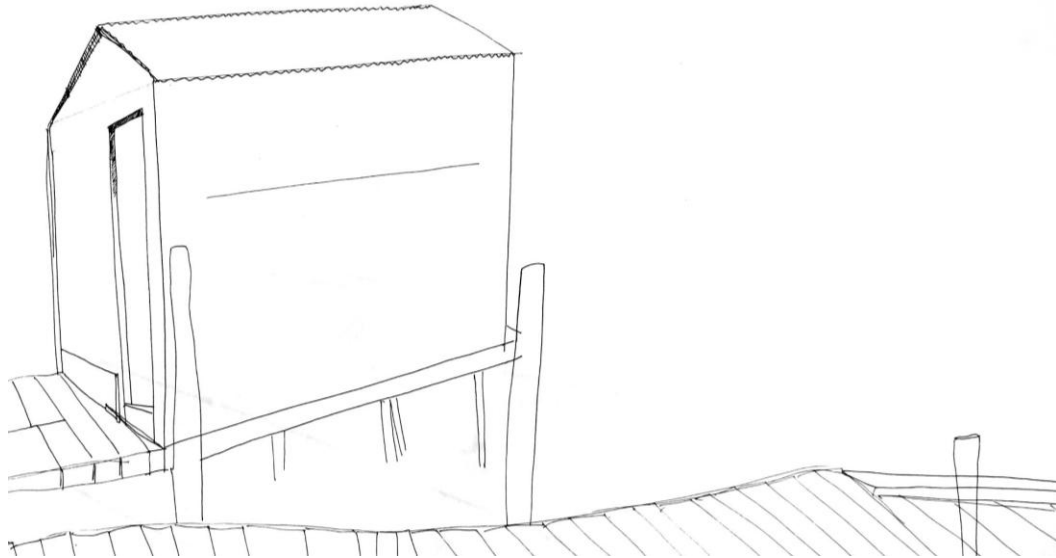





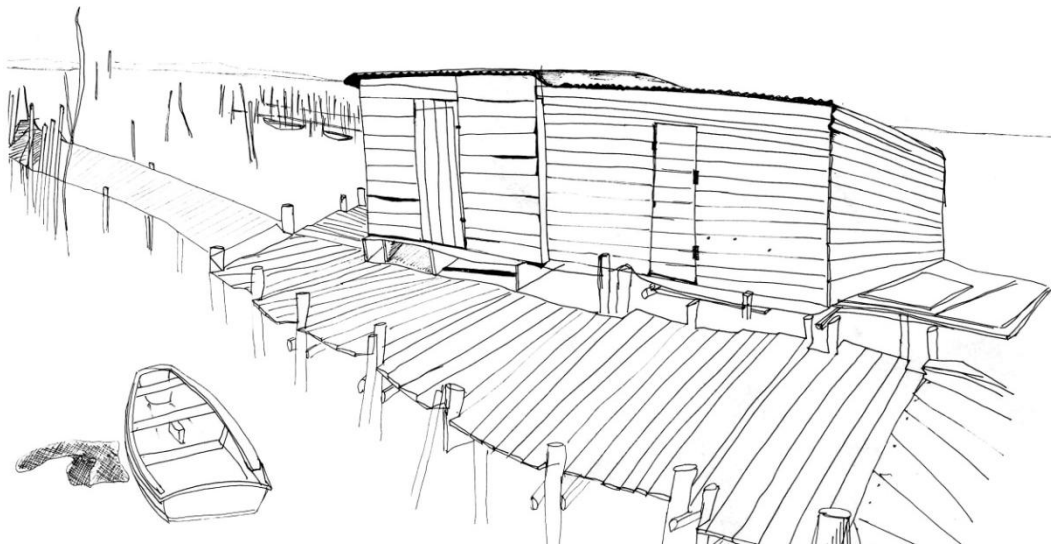

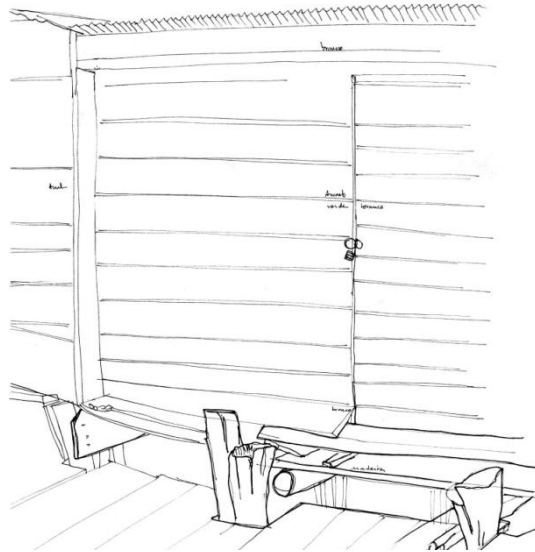



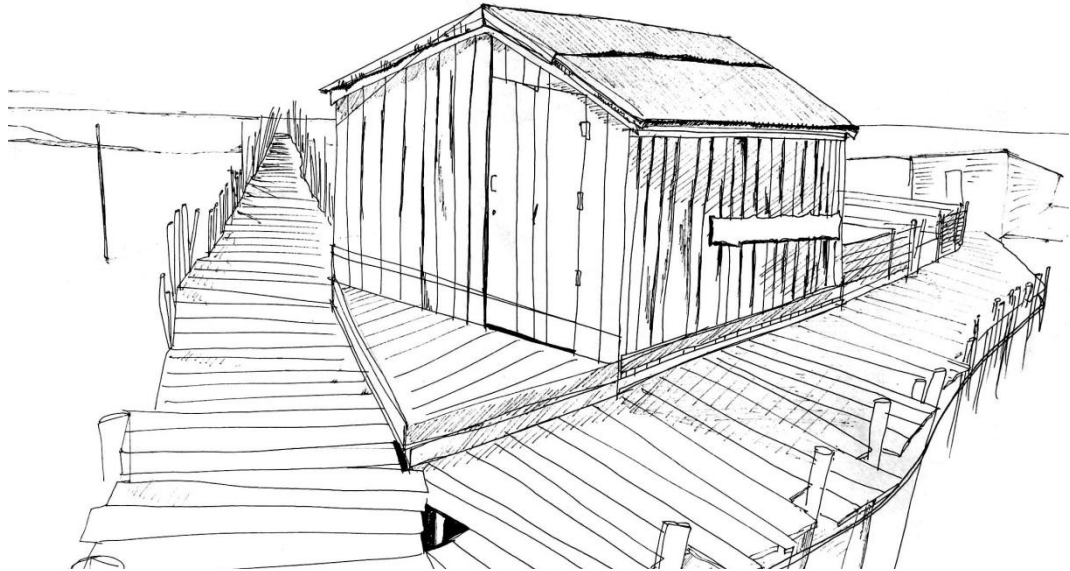



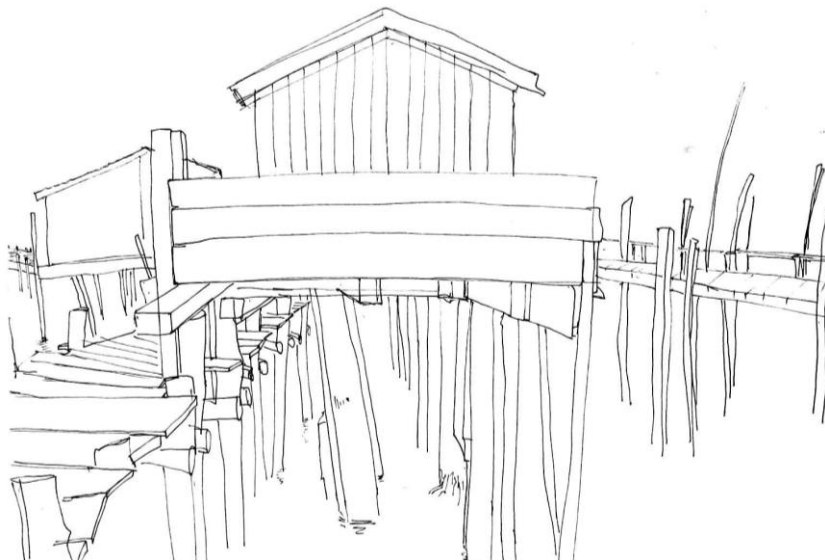

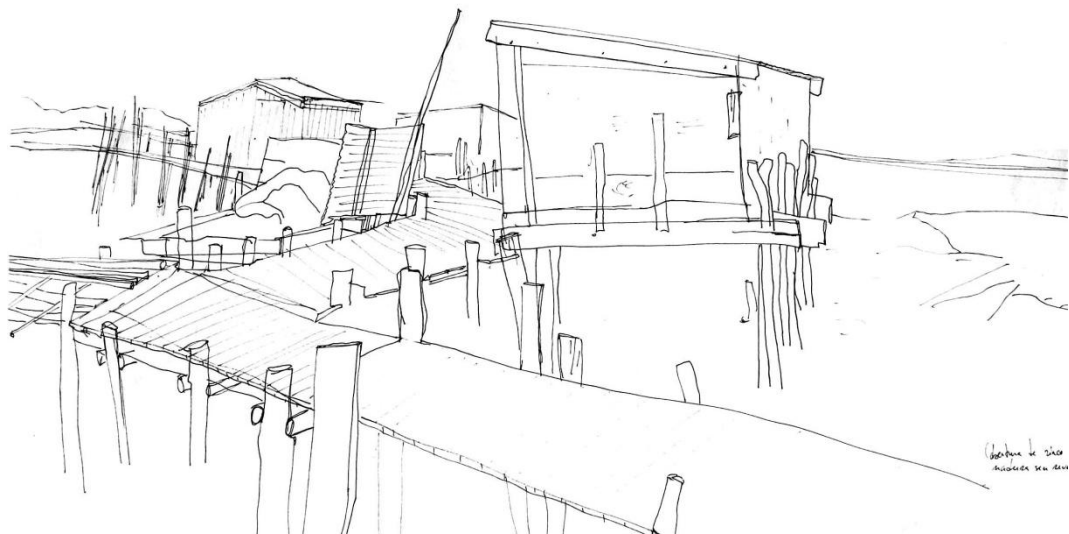

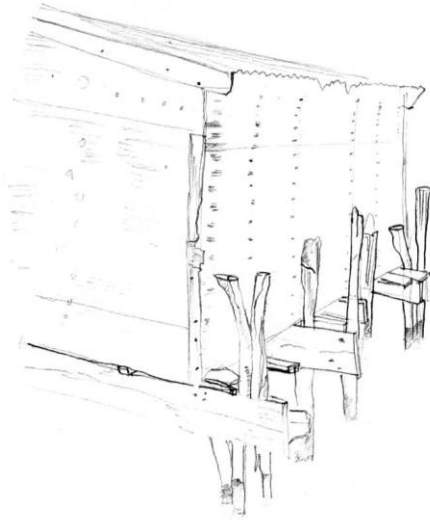

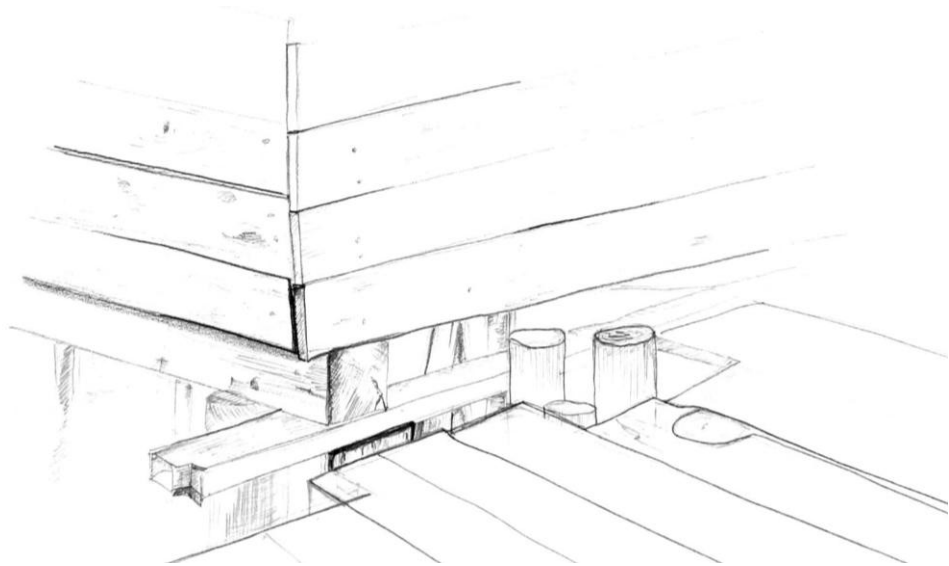

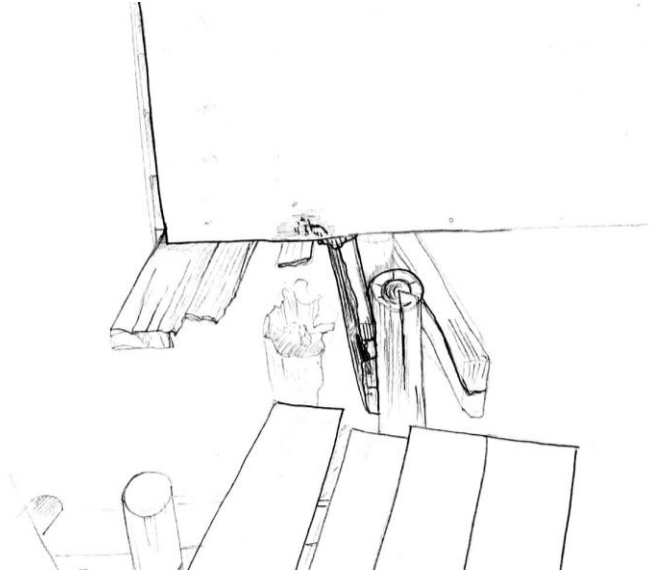

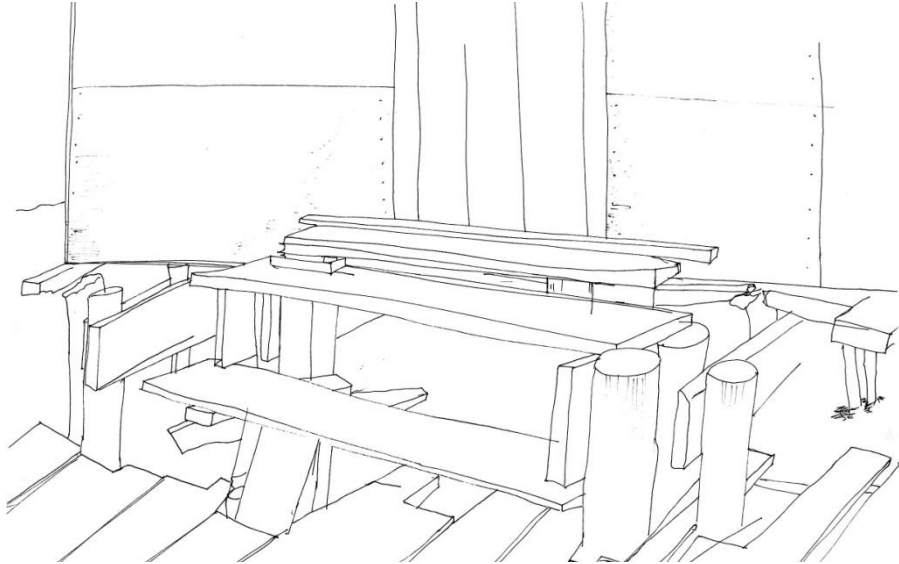

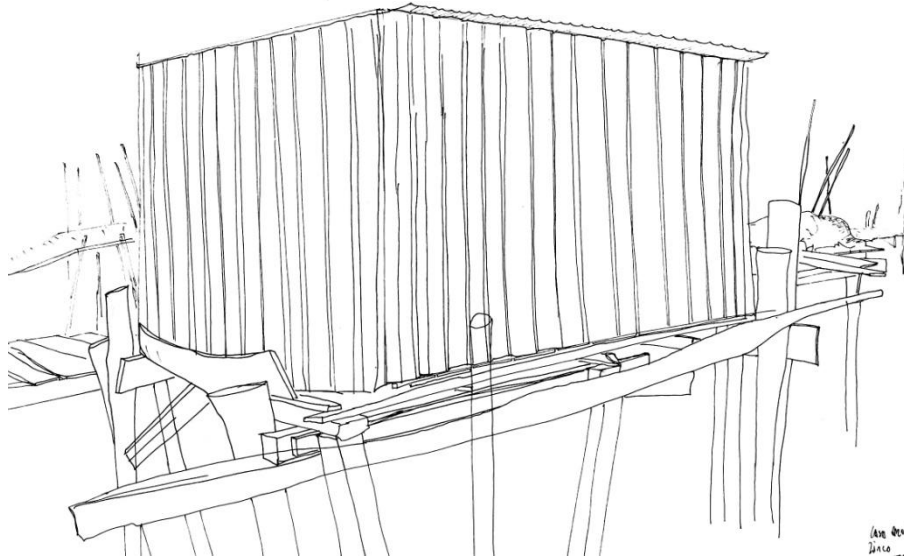

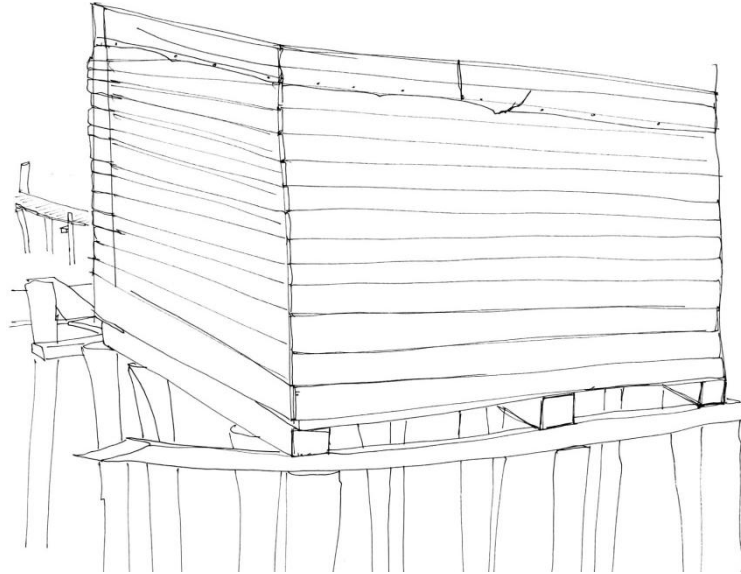

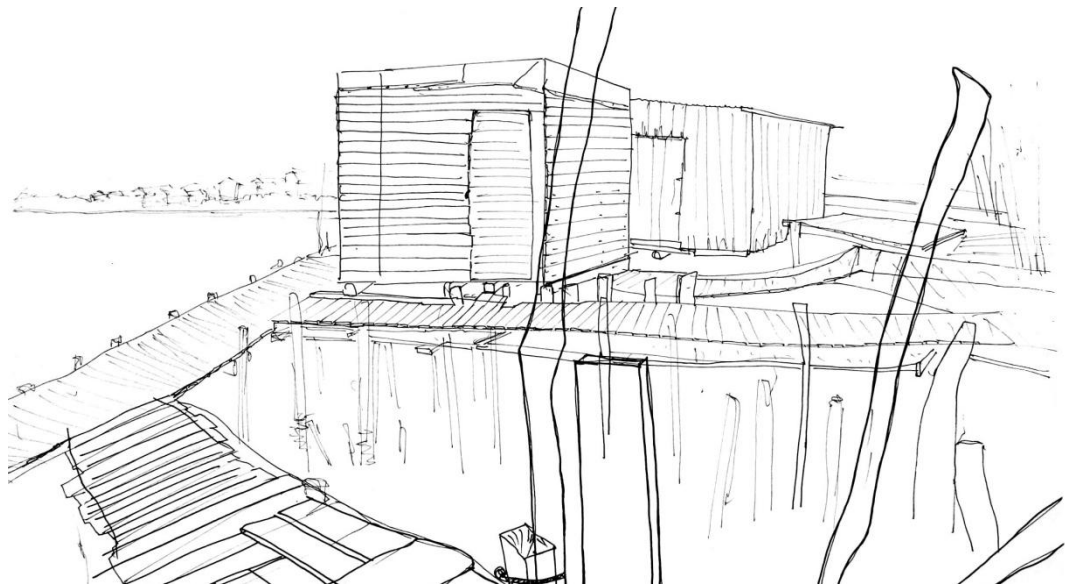

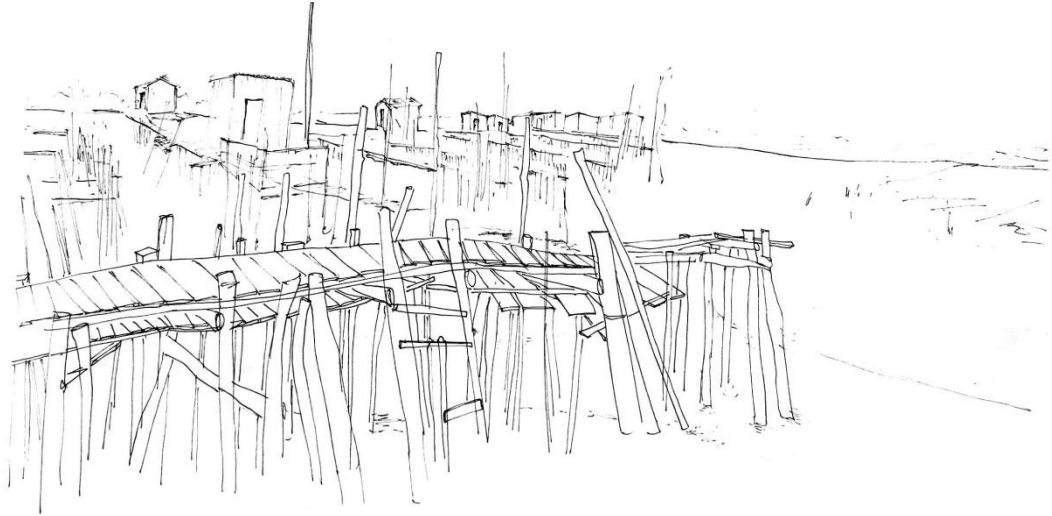

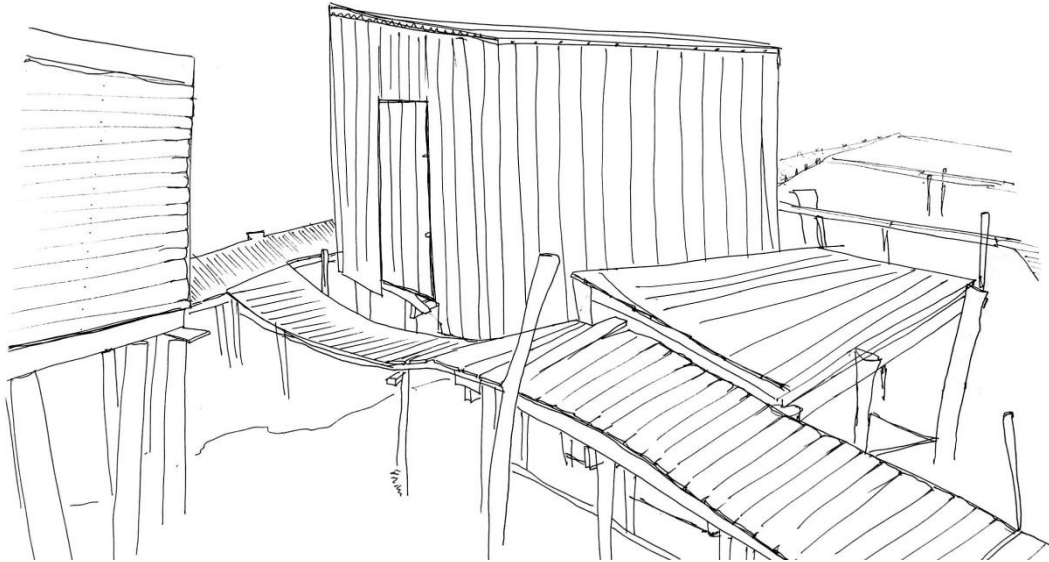

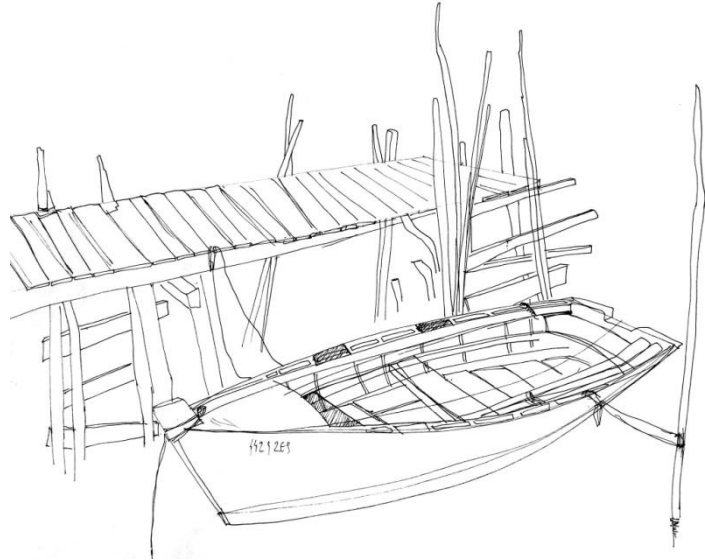

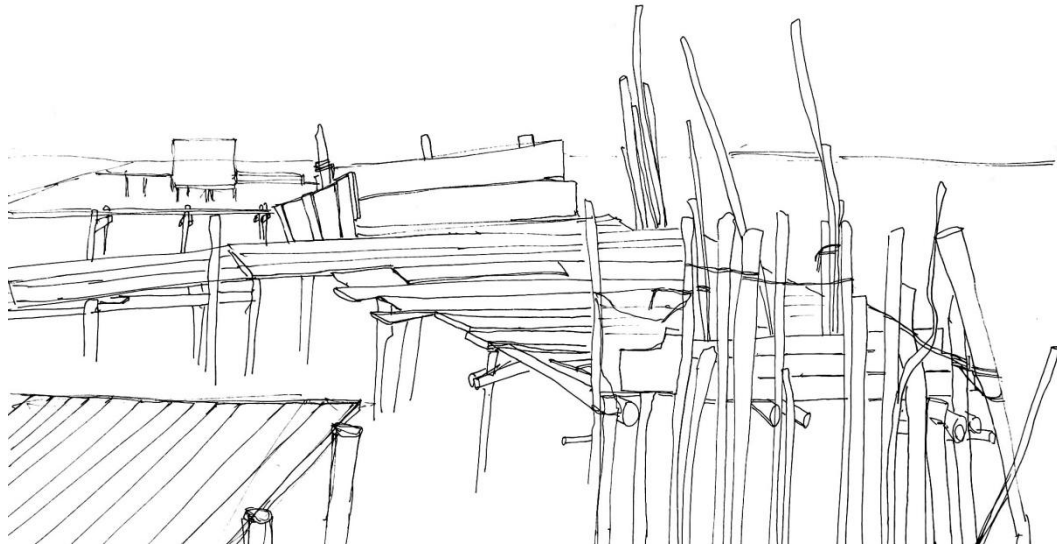

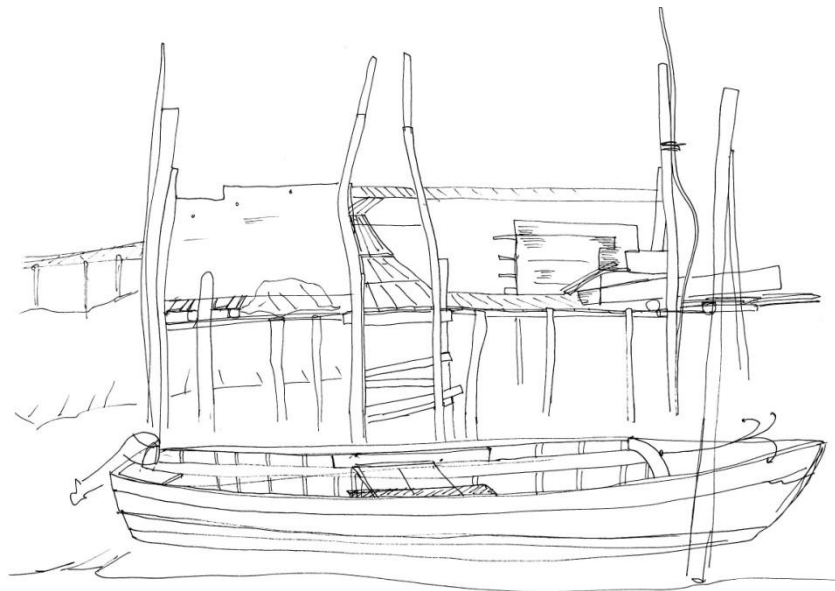

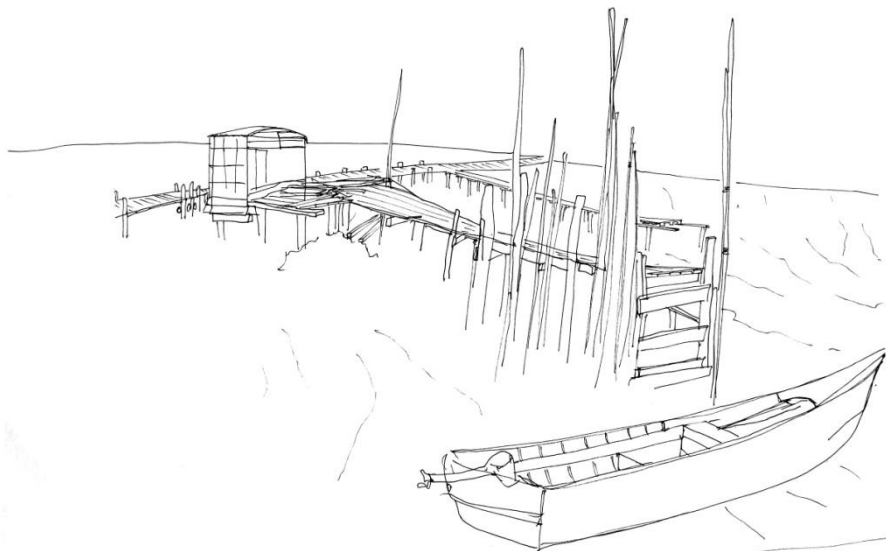

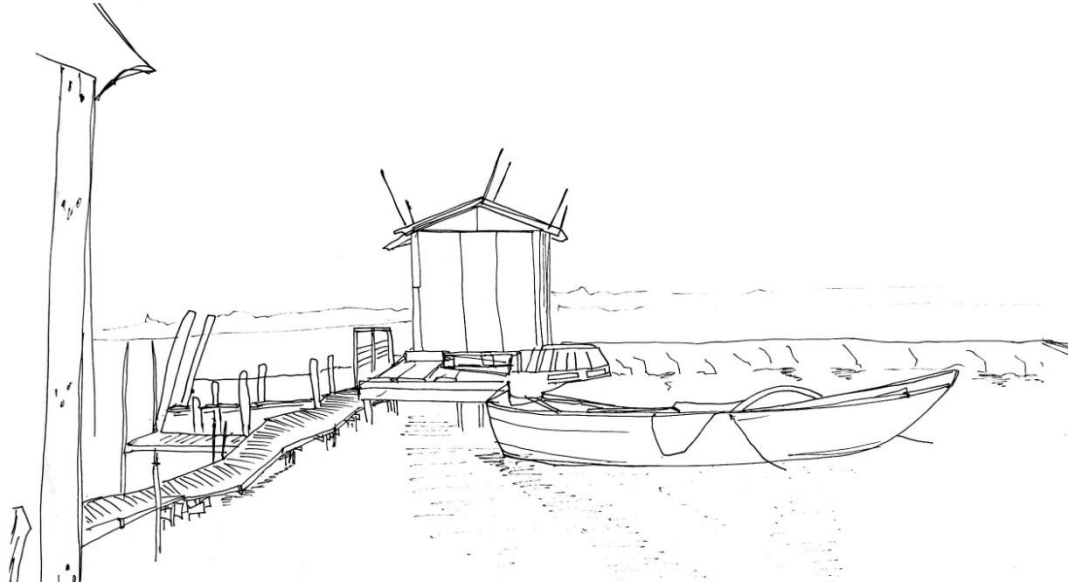

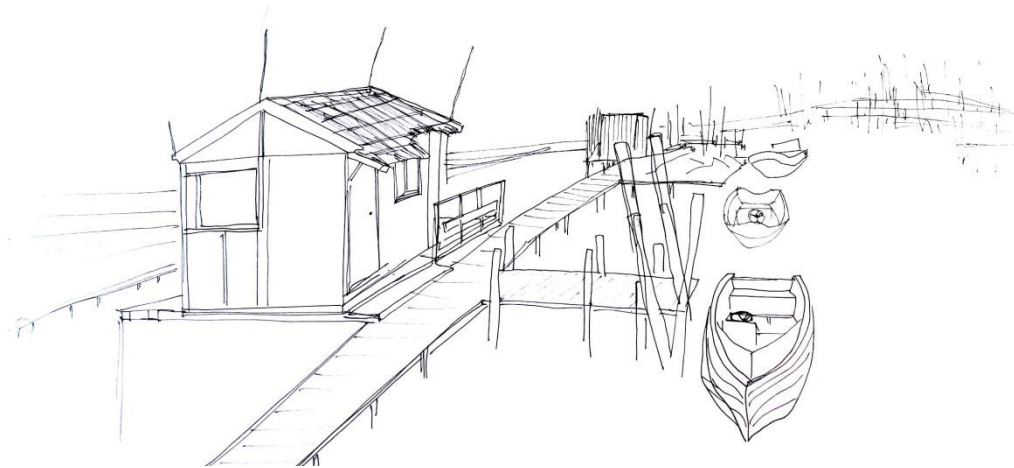

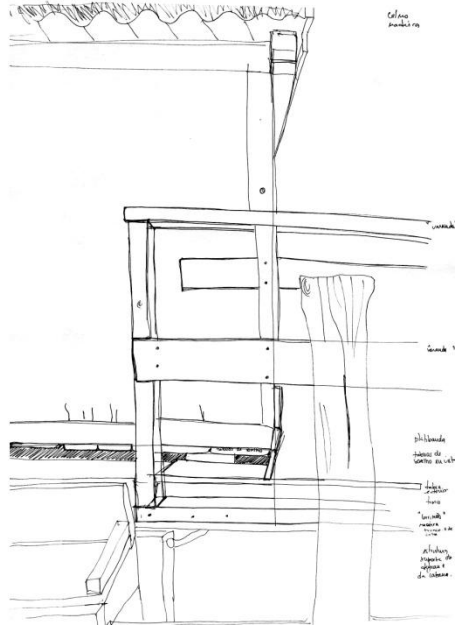

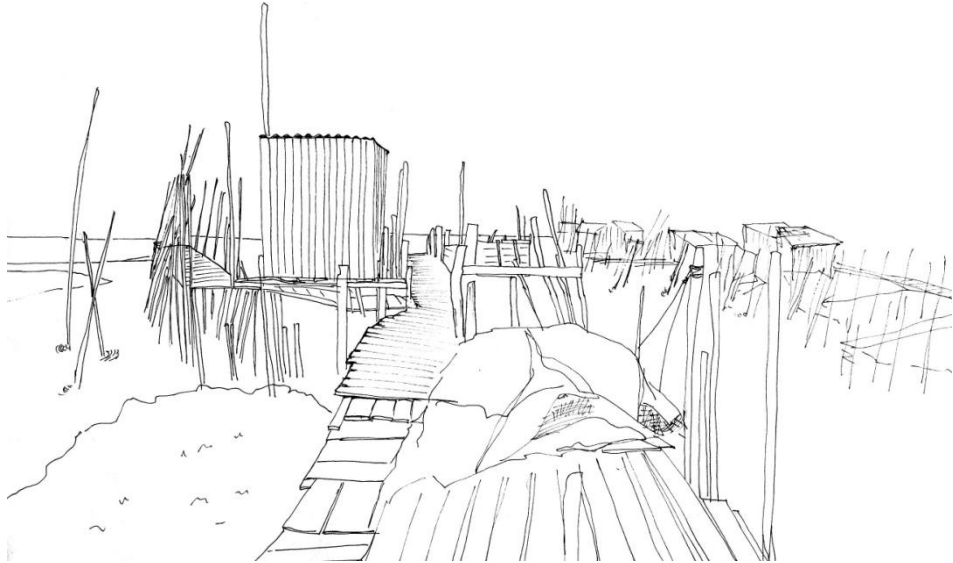

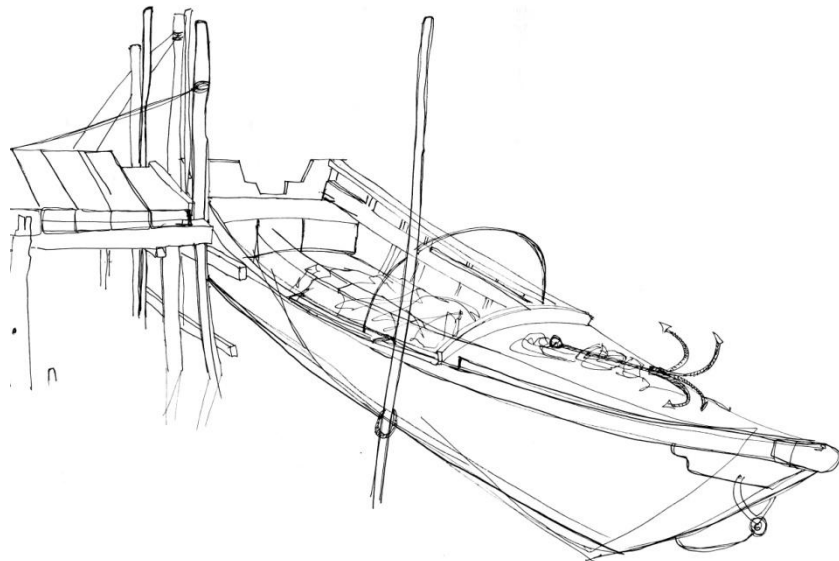

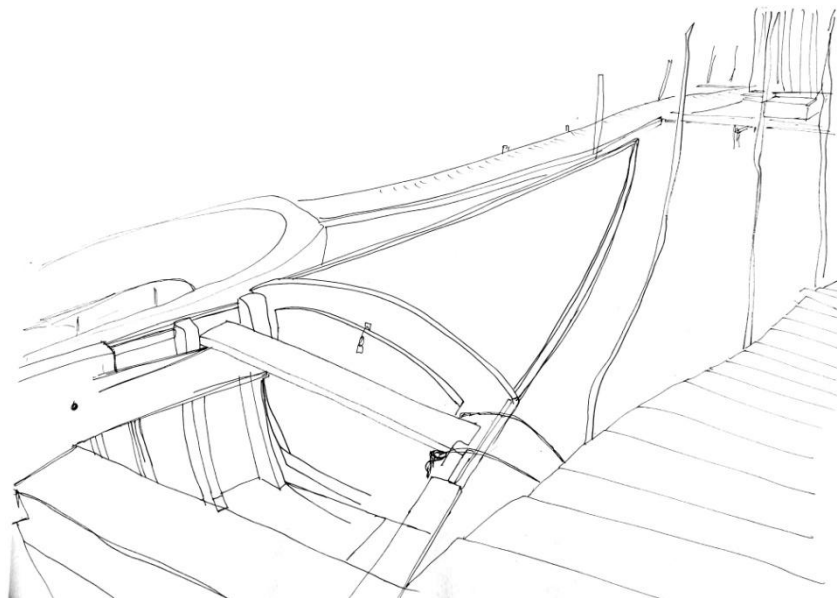

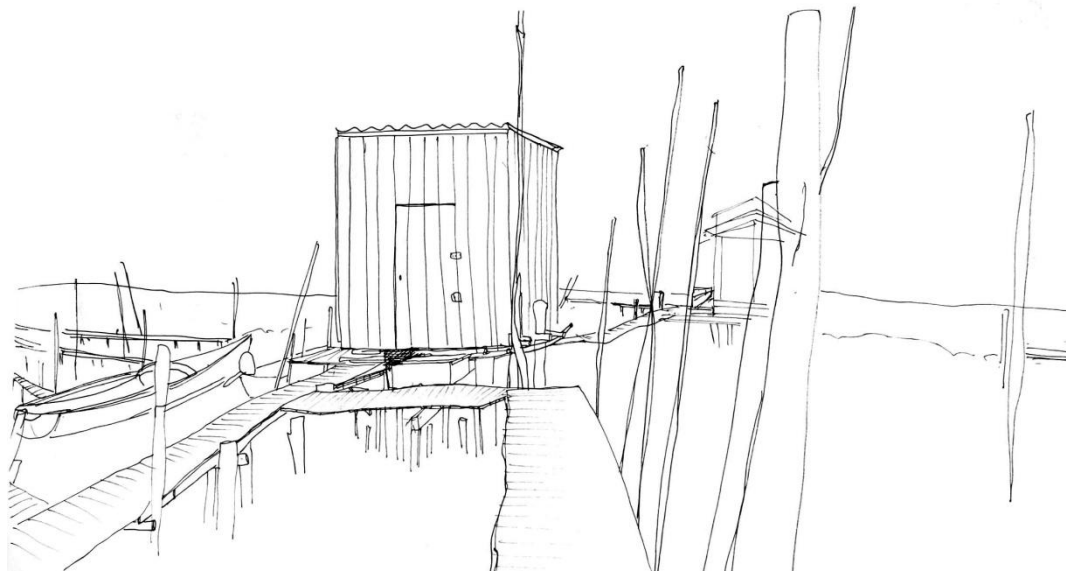

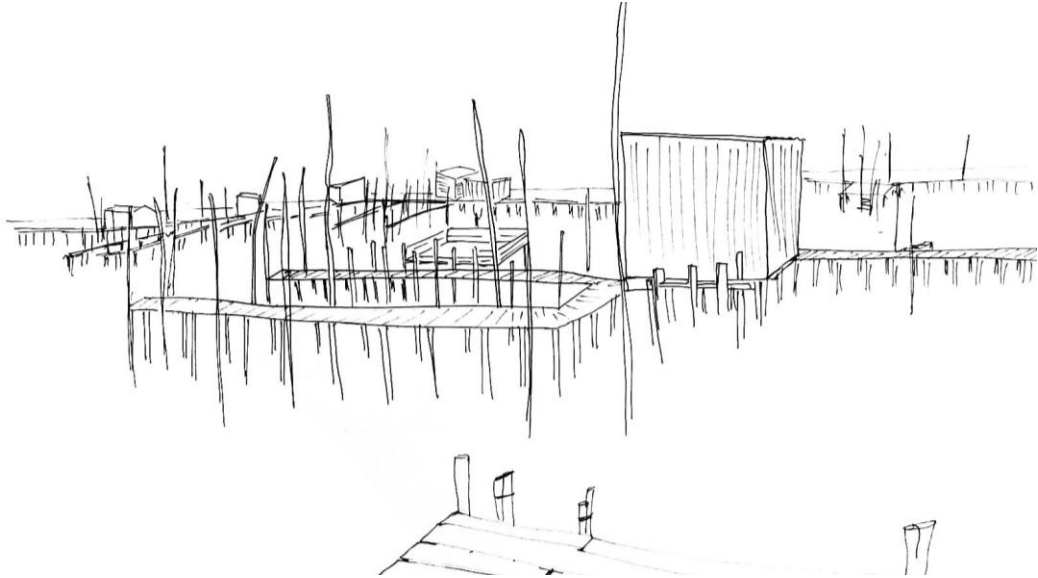

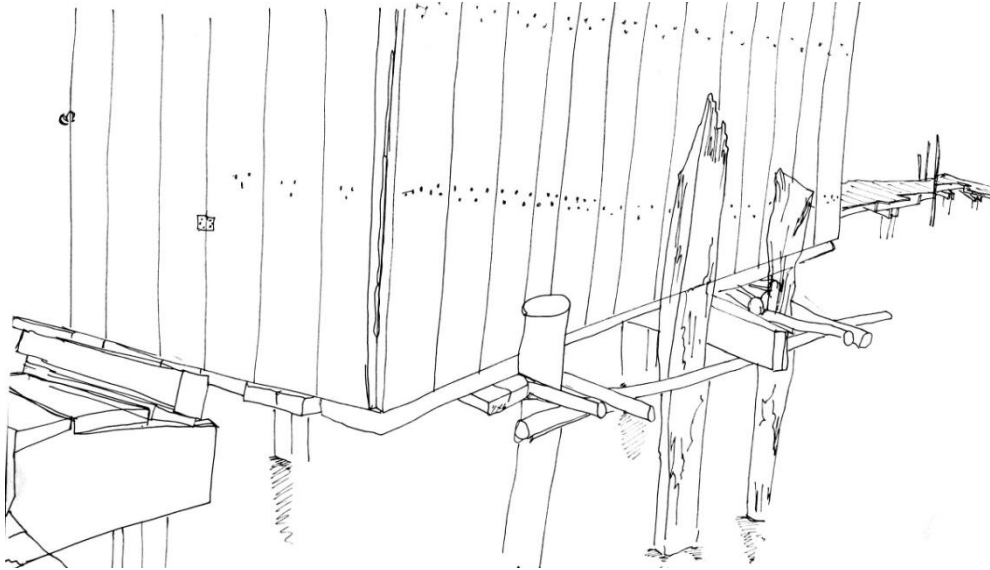

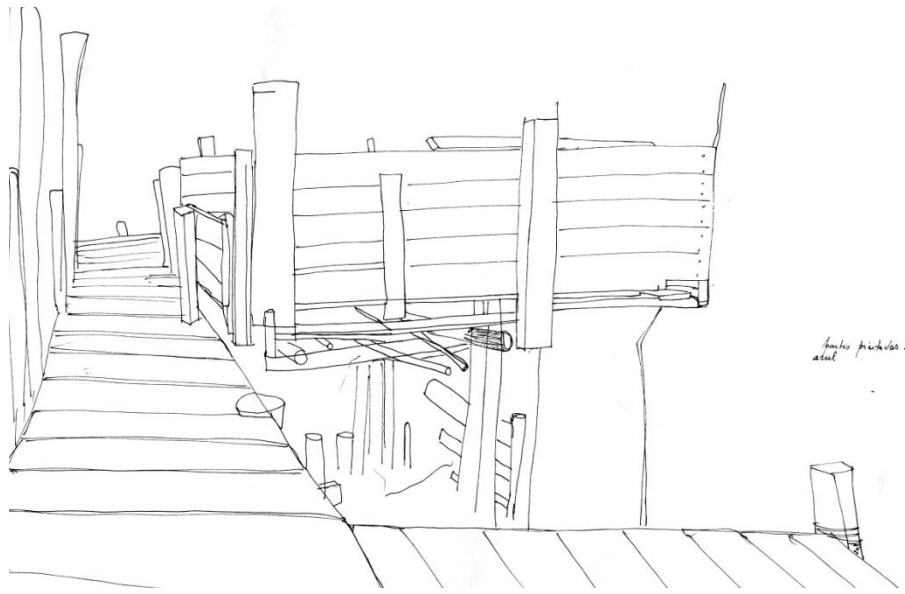

Amos pichas de
asul

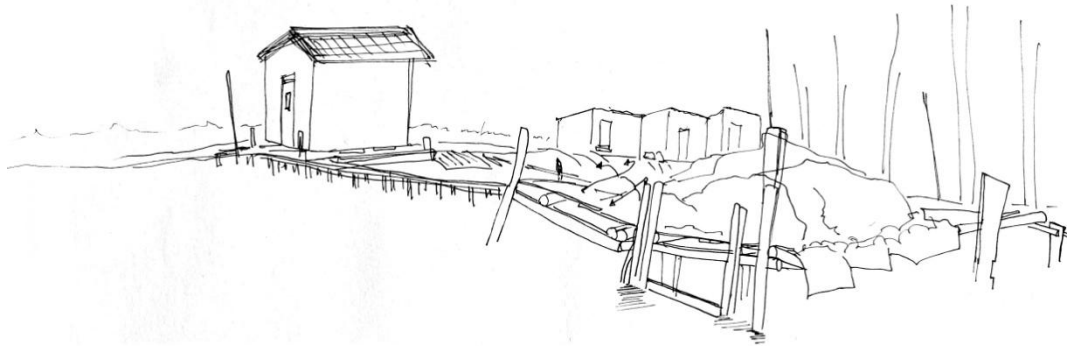

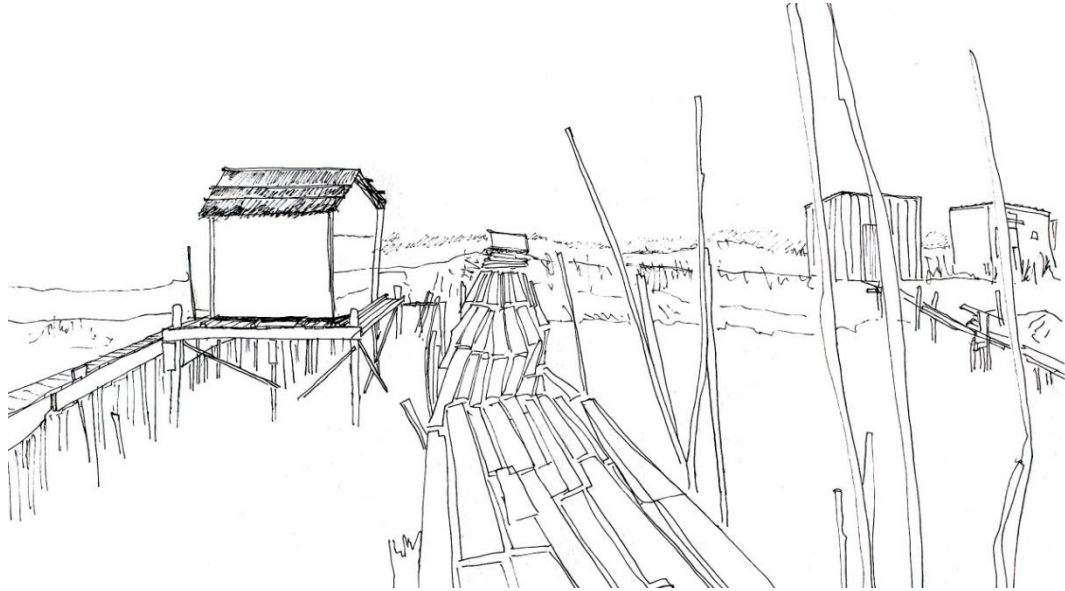

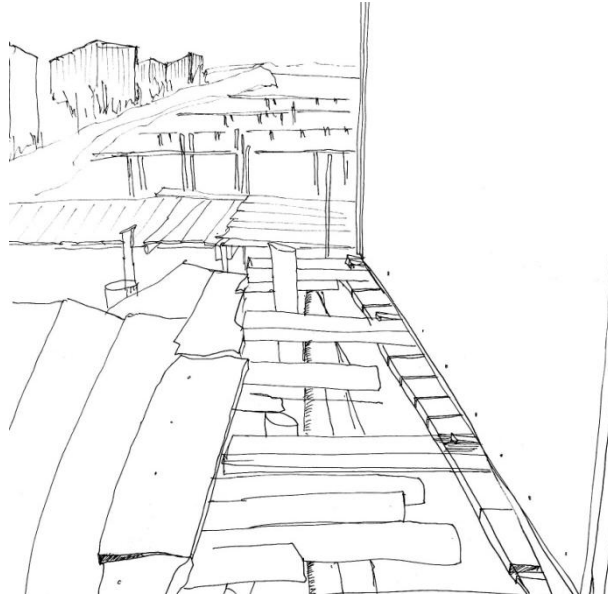

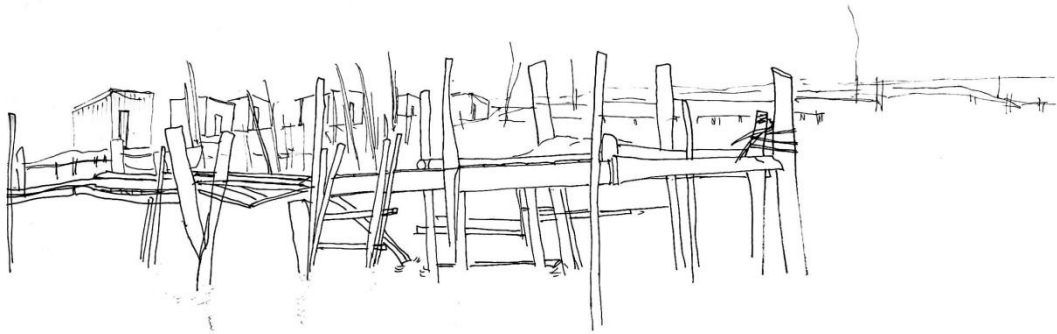

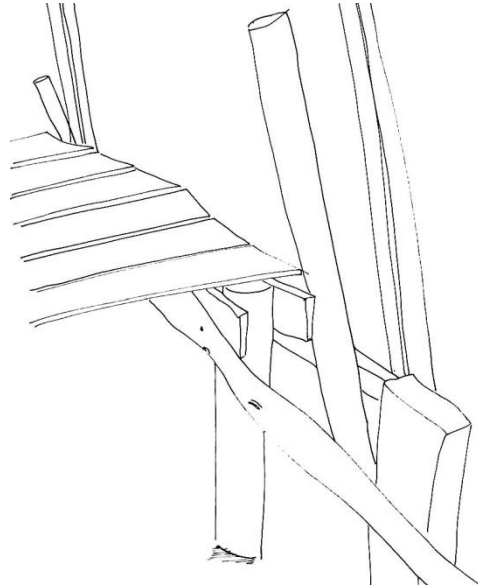

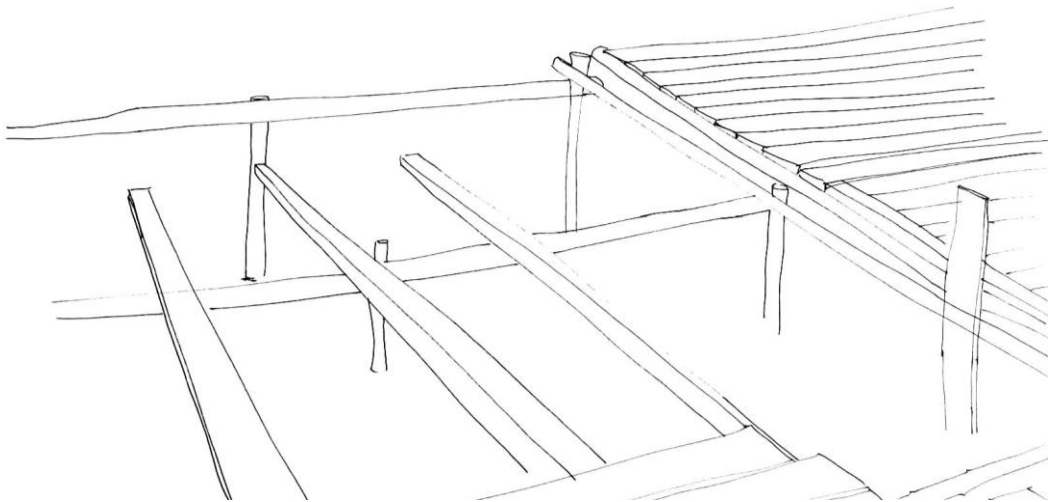

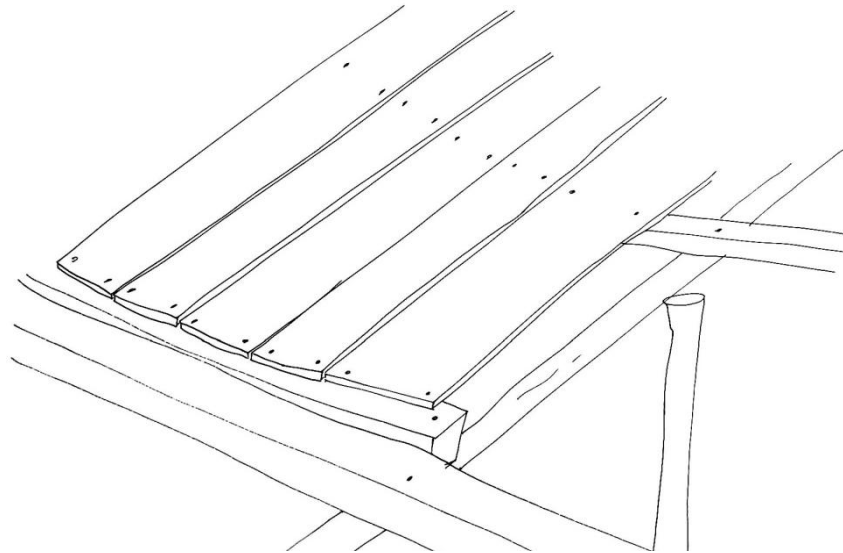



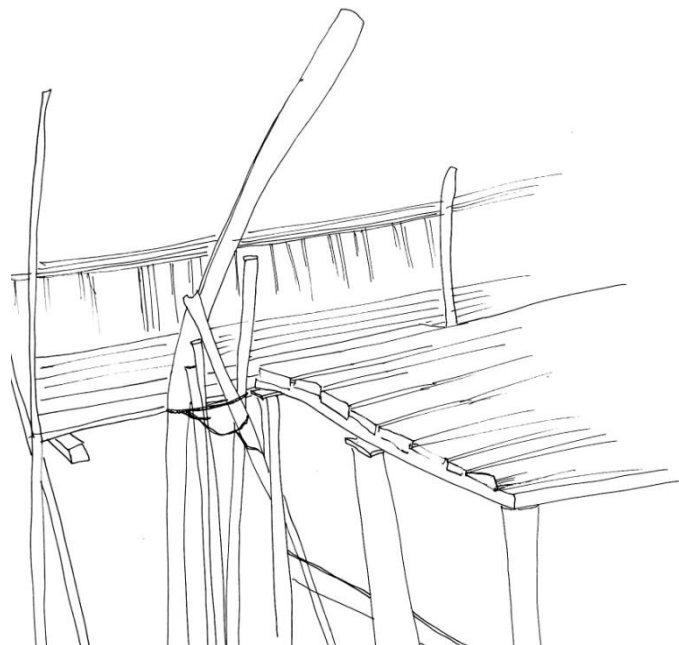

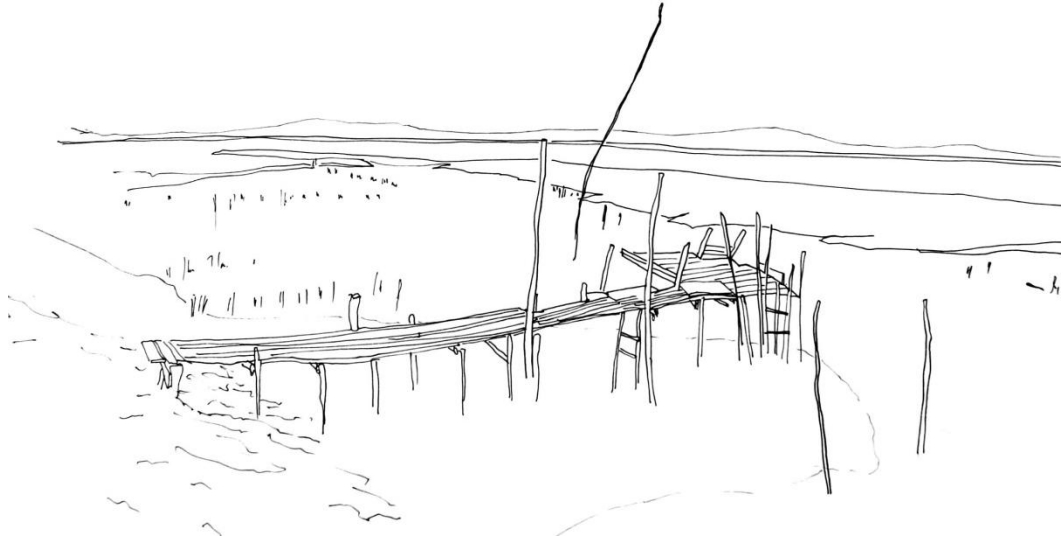





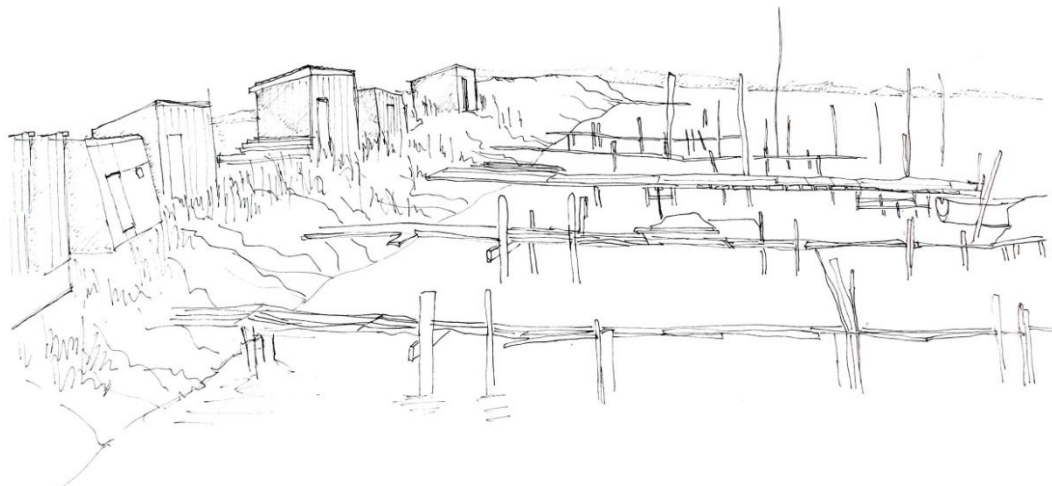

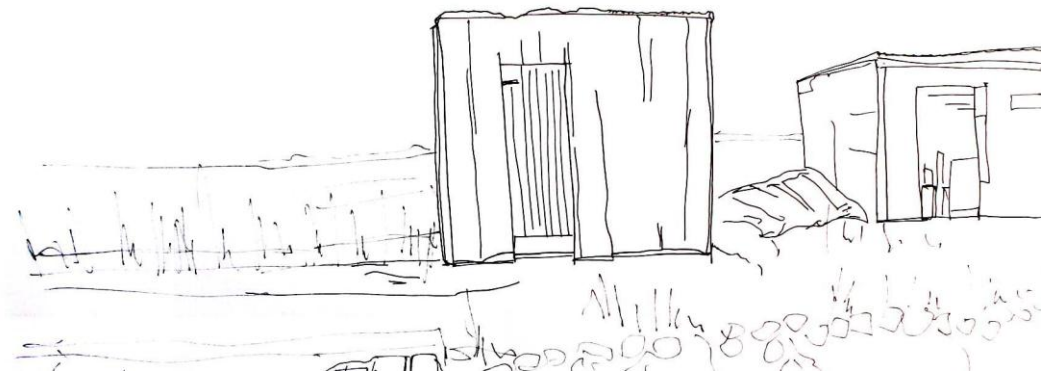

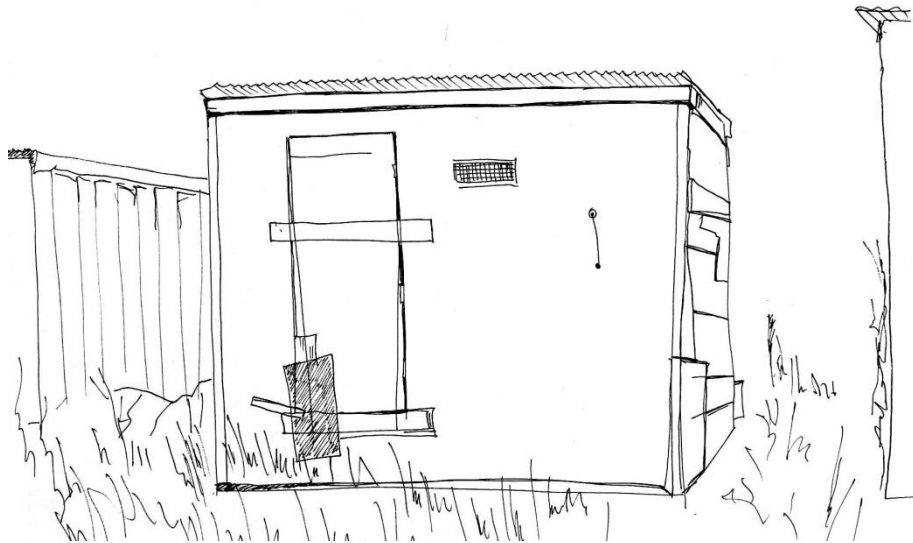



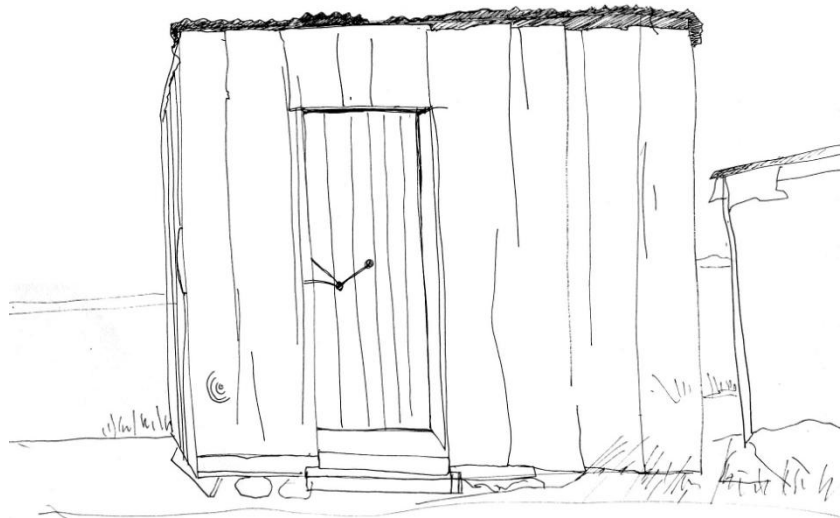

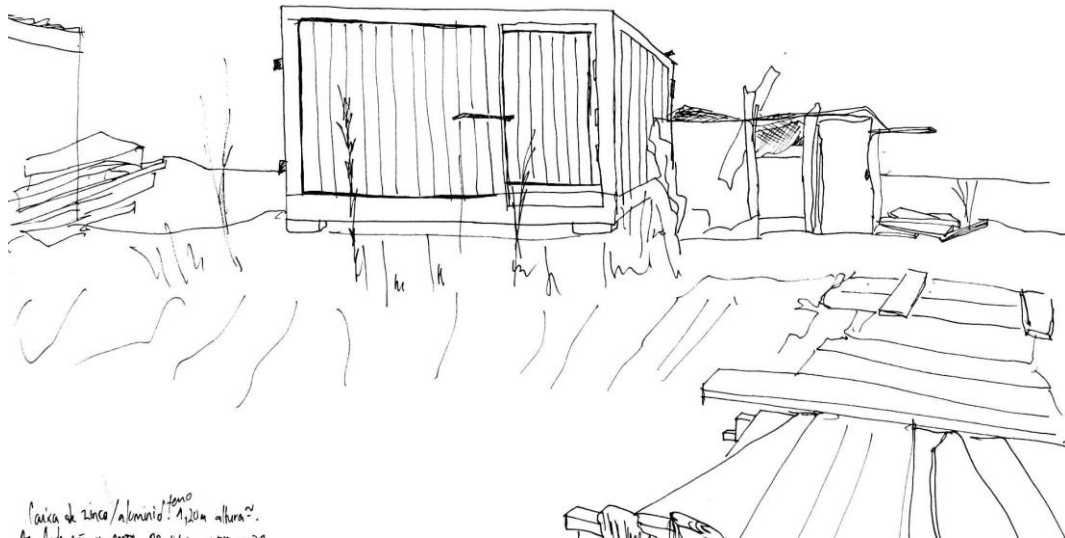

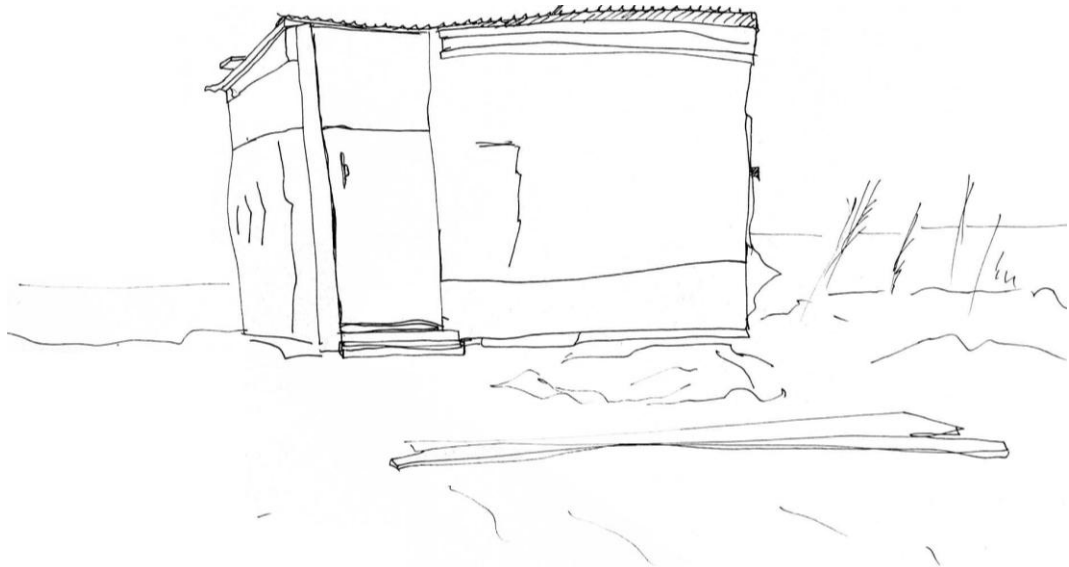

Todos os desenhos foram produzidos no local, no período da presente investigação.

Desenhos: Ana Rita Nunes

O direito de autor pertence ao criador intelectual da obra.

Disposição legal relevante: 164º e 165º do CDADC

ÍNDICE REMISSIVO

1. A Carrasqueira.	3
2. Cabana em colmo.	5
3. Cais Palafítico da Carrasqueira.	7
4. Mapa de desenvolvimento do cais I.	9
5. Mapa de desenvolvimento do cais II.	11
6. Mapa de desenvolvimento do cais III.	13
7. Cais vista nascente.	15
8. Composição de estruturas e barcos.	17
9. Percursos diariamente percorridos pelos pescadores.	19
10. Estruturas palafíticas.	21
11. Caminhos e barcos.	23
12. Barcos.	25
13. Disposição das embarcações.	27

14. Caminhos no enquadramento com a paisagem.	29
15. Ramificações e caminho principal.	31
16. Desnível entre alturas dos caminhos.	33
17. Detalhe construtivo de um caminho em recuperação.	35
18. Detalhe construtivo.	37
19. Junção entre diferentes madeiras: tábuas, prumos e barrotes. Cordas e nós de pesca.	39
20. Detalhe construtivo. Encaixe da estrutura.	41
21. Estrutura 1. Enquadramento.	43
22. Estrutura 1.	45
23. Estrutura 2. Enquadramento.	47
24. Estrutura 2. Enquadramento.	49
25. Estrutura 2. Detalhe construtivo da cobertura.	51
26. Estrutura 2. Caminho de acesso.	53
27. Estrutura 2. Detalhe do piso.	55
28. Estrutura 3. Enquadramento.	57

29. Estrutura 3. Enquadramento.	59
30. Estrutura 3. Detalhe do piso.	61
31. Estrutura 3. Detalhe construtivo. Cobertura/Porta.	63
32. Estrutura 4. Enquadramento.	65
33. Estrutura 4. Detalhe: Caminhos/Tábuas de piso da barreca.	67
34. Estrutura 4. Detalhe da cobertura: Cobertura/Parede/Porta.	69
35. Estrutura 5. Enquadramento.	71
36. Estrutura 5. Enquadramento.	73
37. Estrutura 5. Interior da barreca.	75
38. Estrutura 5. Detalhe da cobertura.	77
39. Estrutura 6. Enquadramento.	79
40. Estrutura 6. Enquadramento.	81
41. Estrutura 6. Cobertura de duas águas em zinco.	83
42. Estrutura 6. Detalhe do remate- Junção entre a parede e a porta.	85
43. Estrutura 7. Enquadramento.	87

44. Estrutura 7. Variação de cores e materiais.	89
45. Estrutura 7. Detalhe das diferenciações entre coberturas de um mesmo conjunto de estruturas.	91
46. Estrutura 8. Enquadramento.	93
47. Estrutura 8. Enquadramento.	95
48. Estrutura 8. Volumetria e detalhe das várias camadas de materiais estruturantes da palafita.	97
49. Estrutura 9. Enquadramento.	99
50. Estrutura 9. Detalhe do posicionamento dos prumos e barrotes.	101
51. Estrutura 9. Detalhe construtivo.	103
52. Estrutura 9. Detalhe construtivo.	105
53. Estrutura 9. Detalhe construtivo da escada de acesso à barreca.	107
54. Estrutura 10. Enquadramento.	109
55. Estrutura 10. Construção à vista.	111
56. Estrutura 11. Enquadramento.	113
57. Estrutura 11. Caminho que leva ao barco.	115
58. Estrutura 12. Enquadramento.	117

59. Estrutura 12. Barco (elemento complementar à barreca e caminho).	119
60. Estrutura 13. Enquadramento.	121
61. Estrutura 14. Enquadramento.	123
62. Estrutura 15. Enquadramento.	125
63. Estrutura 16. Enquadramento.	127
64. Estrutura 16. Enquadramento. Abrigo/Caminho/Barco.	129
65. Estrutura 16. Detalhe construtivo. Identificação de materiais construtivos.	131
66. Estrutura 17. Enquadramento.	133
67. Estrutura 17. Plataforma/Barco.	135
68. Estrutura 17. Barco.	137
69. Estrutura 18. Enquadramento.	139
70. Estrutura 18. Caminho/Abrigo.	141
71. Estrutura 18. Detalhe construtivo.	143
72. Estrutura 19. Enquadramento.	145
73. Estrutura 20. Enquadramento.	147

74. Estrutura 20. Enquadramento.	149
75. Estrutura 20. Detalhe construtivo. Plataforma/ Barreca- piso.	151
76. Estrutura 21. Enquadramento.	153
77. Estrutura 21. Alterações construtivas durante o processo de construção de uma estrutura adjacente.	155
78. Estrutura 21. Início da colocação do piso da nova estrutura adjacente.	157
79. Estrutura 21. Detalhe do piso.	159
80. Estrutura 22. Enquadramento.	161
81. Estrutura 22. Detalhe construtivo.	163
82. Estrutura 23. Enquadramento.	165
83. Estrutura 23. Detalhe construtivo.	167
84. Abrigos em terra.	169
85. Abrigos em terra.	171
86. Abrigo em terra 1 (A partir do cais, da esquerda para a direita).	173
87. Abrigo em terra 2 (A partir do cais, da esquerda para a direita).	175
88. Abrigo em terra 3 (A partir do cais, da esquerda para a direita).	177

89. Abrigo em terra 4 (A partir do cais, da esquerda para a direita).	179
90. Abrigo em terra 5 (A partir do cais, da esquerda para a direita).	181
91. Abrigo em terra 6 (A partir do cais, da esquerda para a direita). O mais antigo abrigo em terra.	183

